

CMS-4
IN-HELMET CARBON MONOXIDE MONITOR
O. M. 29872

DATE OF ISSUE: 07/2019

REVISION: A, 03/20

 **WARNING**

Do not use this equipment before READING this MANUAL and UNDERSTANDING its contents.

These WARNINGS are included for the health and safety of the operator and those in the immediate vicinity. Failure to read and understand these warnings can result in injury or death.

Electronic files include a preface containing the same important information as in the orange cover.

© 2020 CLEMCO INDUSTRIES CORP.
One Cable Car Dr.
Washington, MO 63090
Phone (636) 239-4300
Fax (800) 726-7559
Email: info@clemcoindustries.com
www.clemcoindustries.com



1.0 INTRODUCTION

1.1 Scope of Manual

1.1.1 These instructions cover operation, maintenance, troubleshooting and replacement parts for the CMS-4 Respirator-Mounted Carbon Monoxide Monitor.

1.1.2 The monitor detects the presence of carbon monoxide (CO) inside Apollo supplied-air respirators. The alarm setpoint is preset at 10 parts per million (ppm), which is the maximum permissible exposure level (PEL) of CO for Grade-D breathing air in the USA. Refer to Section 2.5 to change the alarm setpoint to 5 ppm when required by local regulations. The monitor also displays the PEAK level of CO, short-term exposure limit (STEL), and time-weighted average (TWA). Instructions to toggle through the PEAK CO concentrations, STEL, and TWA are explained in Section 4.3.

1.1.3 All respirator users and those responsible for maintenance and calibration of the monitor must read and understand this manual before using the respirator or operating the monitor.

1.2 Safety Alerts

1.2.1 Clemco uses safety alert signal words, based on ANSI Z535.4-2011, to alert the user of a potentially hazardous situation that may be encountered while operating this equipment. ANSI's definitions of the signal words are as follows:



This is the safety alert symbol. It is used to alert you to potential physical injury hazards. Obey all safety messages that follow this symbol to avoid possible injury or death.

NOTICE

Notice indicates information that is considered important, but not hazard-related, if not avoided, could result in property damage.

CAUTION

Caution indicates a hazardous situation that, if not avoided, could result in minor or moderate injury.

WARNING

Warning indicates a hazardous situation that, if not avoided, could result in death or serious injury.

DANGER

Danger indicates a hazardous situation that, if not avoided, will result in death or serious injury.

1.3 Table of Contents

Topic	Page	Section
INTRODUCTION	1	1.0
Scope of Manual	1	1.1
Safety Alerts	1	1.2
Table of Contents	1	1.3
Specifications	2	1.4
Description of Operation	2	1.5
Ancillary Equipment Requirements	3	1.6
Components and Functions	3	1.7
Case	3	1.7.1
Sensor Retainer	3	1.7.2
Sensor	3	1.7.3
Sensor Gasket.....	3	1.7.4
Charcoal Filter (black)	3	1.7.5
Hydrophobic Filter (white)	3	1.7.6
LCD (liquid crystal display).....	3	1.7.7
Control Buttons	4	1.7.8
Alarm-Lights	5	1.7.9
Audible Alarm	5	1.7.10
Vibrating Alarm	5	1.7.11
Lithium Battery (a spare is included).....	5	1.7.12
SETUP - INSTALLATION, STARTUP, AND OPERATION	5	2.0
Installation	5	2.1
Prepare Mounting Clip	5	2.1.1
Installation in Apollo 20	5	2.1.2
Installation in Apollo 60 and Apollo 600	6	2.1.3
Turning ON and Startup Procedure	6	2.2
Setting Date and Time	6	2.3
Performing a Fresh-Air Adjustment	7	2.4
Turning OFF the CMS-4	7	2.5
ALARMS	8	3.0
Alarm Indications	8	3.1
Alarm Indications Table	8	3.2
Resetting the Monitor After an Alarms	8	3.3
Responding to CO Alarms	8	3.4
CO Alarm	8	3.4.1
Over Range Alarm	8	3.4.2
Battery Alarms	8	3.4.3
Sensor Failure Alarm	10	3.4.4
Clock Failure Alarm	10	3.4.5
System Failure Alarm	10	3.4.6

Alarm Setpoints	10	3.5
Changing Alarm Setpoints.....	10	3.6
Changing alarm setpoints to 5 ppm	10	3.6.1
Changing alarm setpoints to 10 ppm	11	3.6.2
MANEUVERING THROUGH MENU MODES	12	4.0
Measuring Mode	12	4.1
Entering Measuring Mode	12	4.1.1
User Mode	12	4.2
Entering User Mode	12	4.2.1
Tips for Using User Mode	12	4.2.2
Display Mode	14	4.3
Entering Display Mode	14	4.3.1
Tips for Using Display Mode	14	4.3.2
Display Mode Menu Item (Ref. Table)	15	4.3.4
Displaying the PEAK Screen	15	4.3.5
Displaying the STEL Screen	15	4.3.6
Displaying the TWA Screen	15	4.3.7
Maintenance Mode	16	4.4
Return to Factory Default Settings.....	16	4.4.1
Entering Maintenance Mode.....	16	4.4.2
Performing a Default (M.DEF)	16	4.4.3
CALIBRATION, FRESH-AIR ADJUSTMENTS, BUMP TEST, and STORAGE	16	5.0
Calibration Schedule	17	5.1
Performing Fresh-Air Adjustments	17	5.2
Fresh-Air Adjustment with Ambient Air.....	17	5.2.1
Fresh-Air Adj. with 0 PPM CO Test Gas	17	5.2.2
Prepare Calibration Connector	18	5.3
Connect Calibration Cup to Monitor.....	18	5.4
Remove Calibration Cup from Monitor.....	19	5.5
Performing a Bump Test	19	5.6
Calibrating the CMS-4	20	5.7
Storing the Calibration Kit and Test Gas.....	21	5.8
MAINTENANCE	21	6.0
Replacing the Lithium Battery	21	6.1
Replacing the Sensor	22	6.2
Replacing the Charcoal Filter	23	6.3
Replacing the Hydrophobic Filter	23	6.4
TROUBLESHOOTING	24	7.0
REPLACEMENT PARTS	25	8.0
System Replacement Parts	25	8.1
Monitor Replacement Parts	25	8.2

1.4 Specifications

Target Gas	Carbon Monoxide (CO)
Detection Range	0 to 1000 ppm
Display Increment	0 – 500 1 ppm
	505 – 1000 5 ppm
CO Sensor	Electrochemical
CO Test Gas	25 ppm
*Warning Alarm	5 to 10 ppm
*Alarm Point, Low	5 to 10 ppm
*Alarm Point, High	5 to 10 ppm

* Refer to Section 3.6 to change alarm setpoints.

1.5 Description of Operation

⚠ WARNING

The CMS-4 detects carbon monoxide, which can be life threatening. When using the CMS-4, follow the instructions, maintenance, calibration schedule, and warnings in this manual to assure proper and safe operation of the monitor and to minimize the risk of personal injury. Carbon monoxide poisoning can result in death or serious injury.

1.5.1 The CMS-4 respirator-mounted carbon monoxide monitor detects the presence of carbon monoxide (CO) inside a supplied-air respirator.

1.5.2 CO is displayed in parts per million (ppm). The current maximum exposure limit in the United States for carbon monoxide in Grade D compressed breathing air is 10 parts per million. If CO concentrations reach the exposure limit, three alarms occur. The audible alarm alternates between a high and low tone at about once per second, the LED lights flash twice per second, and the vibrator pulses twice per second. If an alarm occurs, remove the respirator as soon as it is safe to do so.

1.5.3 The CMS-4 offers a full range of features, including:

- Digital liquid crystal display (LCD)
 - Visual, audible, and vibrating alarms that alert the user to CO concentrations, malfunction, low battery, and other conditions as noted within this manual.
 - Low battery alarm
 - Sensor fail alarm
 - Current time display
 - Up to 4,000 hours of operation from one battery
 - * Peak is the highest CO concentration since the monitor was last turned on. Refer to Section 4.3.5 for additional information on the PEAK screen.
 - * STEL is an acronym for short-term exposure limit. It is the average reading over the last 15 minutes. Refer to Section 4.3.6 for additional information on the STEL screen.
 - * TWA is the time-weighted average over the last 8 hours. Refer to Section 4.3.7 for additional information on the TWA screen.
- * Although some may find PEAK concentrations, STEL, and TWA information useful, it is not pertinent for supplied-air respirator use because the maximum exposure limit for Grade D breathing the USA is 10 ppm.

1.6 Ancillary Equipment Requirements

1.6.1 In addition to the monitor, the following equipment is required to operate and maintain the CMS-4 Monitor:

- Calibration connector with 0.5 LPM fixed-flow slide valve, tubing, and calibration cup: Stock No. 29767.
- 25 ppm Test Gas: Stock No. 25573.

1.7 Components and Functions

Items included with the monitor package are shown in Figure 1. Callouts shown in Figure 2 are items needed to perform routine functions.

1.7.1 **Case:** The CMS-4's sturdy, high-impact plastic case is dust proof, water resistant, and radio frequency (RF) resistant.

The digital LCD display is visible through the clear window on the front of the case. During normal operation (Measuring Mode), it displays

- CO (Type of gas detection)
- Remaining battery life
- Current time
- The heart symbol pulses, indicating the monitor is in normal operating status.

In other modes, the LCD displays functions necessary to operate and maintain the monitor. Refer to menu modes in Section 4.0.

Below the LCD are two black control buttons: AIR and POWER/MODE. The operator uses the buttons to make selections and adjustments through various menus. Refer to Section 1.7.8 for button functions

To the left of the LCD is the audible alarm opening, which is located inside the case.

1.7.2 **Sensor Retainer:** The sensor retainer is located on the right side of the case and allows access to the filters, sensor gasket, and sensor.

1.7.3 **Sensor:** The sensor is held in its socket by the sensor retainer. The CO sensor is an electrochemical cell that consists of two precious-metal electrodes in a dilute acid electrolyte. A gas-permeable membrane covers the sensor face and allows gas to diffuse into the electrolyte. The gas reacts in the sensor and produces a current proportional to the concentration of the target gas. The current is amplified by the CMS-4's circuitry, converted to a measurement of gas concentration, and displayed on the LCD.

1.7.4 **Sensor Gasket:** The sensor gasket fits over and seals around the sensor.

1.7.5 **Charcoal Filter (black):** A black charcoal filter is placed into a recess in the filter gasket over the CO sensor. The charcoal filter disk scrubs H₂S and certain hydrocarbons out of the sample to avoid false CO readings. If false or elevated CO readings are noticed, especially in the presence of H₂S, change the charcoal filter. Refer to Section 6.3: Replacing the Charcoal Filter.

1.7.6 **Hydrophobic Filter (white):** The white, circular hydrophobic filter sits into the larger recess on the filter gasket, on top of the charcoal filter.

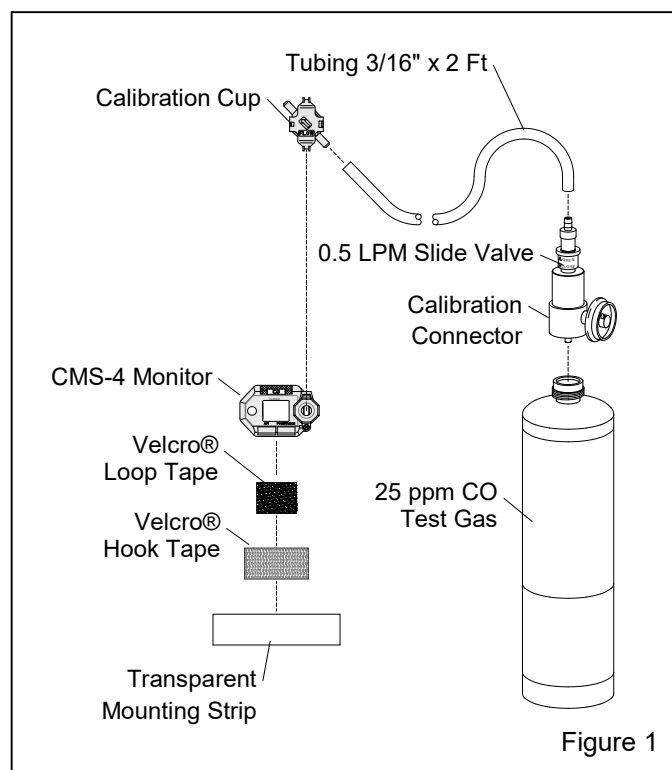

Figure 1

1.7.7 **LCD:** A digital LCD (liquid crystal display) is visible through the clear plastic window on the front of the case. During normal operation in Measuring Mode, the LCD displays CO concentrations, the time, remaining battery life, and the heart symbol pulses, indicating the monitor is in normal operating status. The LCD also shows information for each of the CMS-4's operating modes. Once the monitor is ON, pressing the POWER/MODE or AIR button turns on the LCD backlight for 30 seconds. NOTE: Except in dark places, the display is easily seen without the backlight.

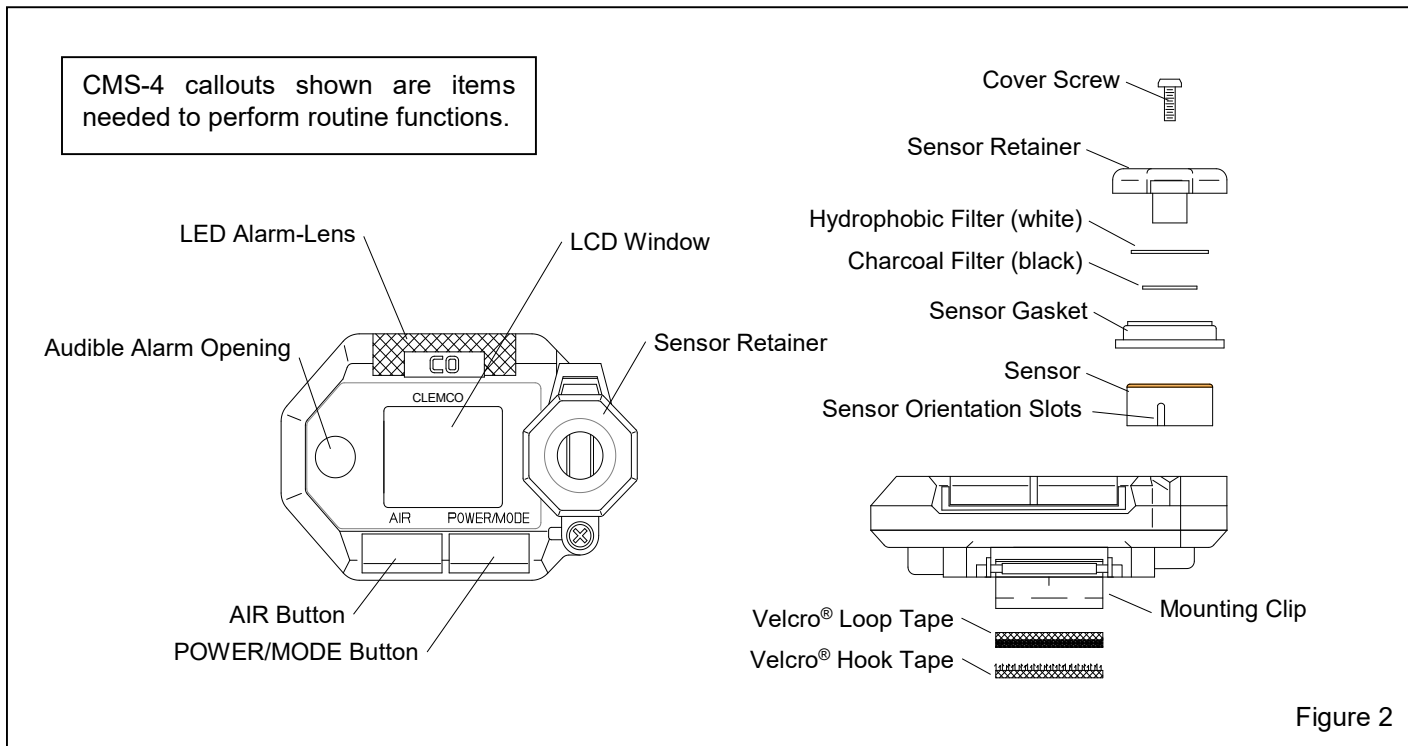

Figure 2

1.7.8 Control Buttons: Two control buttons, AIR and POWER/MODE, are located below the LCD. The functions performed by the control buttons are summarized in the table in Figure 3.

They turn the CMS-4 ON and OFF. They control what is displayed on the LCD, including time, gas concentrations, as well as other messages. They also allow for a fresh-air adjustment, change alarm points, change the time, and calibrate the instrument.

NOTE: Important points to remember are:

1. The AIR button scrolls through items on the menus much like a cursor. Once the menu item is selected, use the POWER/MODE to enter the selection into the microprocessor.
2. To reverse the direction of change (i.e. from increasing to decreasing or vice versa):
 - 1) Press and hold AIR.
 - 2) Immediately press POWER/MODE and then release both buttons.

NOTE: Each screen displays for 20 seconds. If you do not press a button within 20 seconds, the CMS-4 automatically returns to Measuring Mode.

Button	Function
POWER/MODE	<ul style="list-style-type: none"> • Turns the monitor ON and OFF. • Activates Display Mode. • Enters instruction into CMS-4's microprocessor. • Resets alarm after an alarm condition. <p>Also</p> <ul style="list-style-type: none"> • Turns the LCD backlight on (when monitor is on).
AIR	<ul style="list-style-type: none"> • Activates the Demand Zero function (adjusts the CMS-4's fresh-air baseline). • Enters instructions into the CMS-4's microprocessor. • Increases the value of a parameter available for adjustment. • Scrolls through parameter options. <p>Also</p> <ul style="list-style-type: none"> • Turns the LCD backlight on (when monitor is on).

Figure 3

1.7.9 Alarm-Lights: Two LED alarm-lights are located above the LCD. The red alarm-lights show through the reflective lenses. The LED's alert the user to CO gas, low battery, and failure alarms. The lights flash once during the startup sequence.

1.7.10 Audible Alarm: An opening on the left side of the top case allows the alarm's sound to exit the case. The alarm sounds for CO gas, unit malfunctions, low battery voltage, and as an indicator during normal use of various display options. It beeps once during the startup sequence. Refer to Section 3.1 for alarm indications.

1.7.11 Vibrating Alarm: A vibrating motor mounted inside the case vibrates for CO gas alarms, unit malfunctions, and as an indicator during normal use of the various modes of the CMS-4. It vibrates briefly during the startup sequence.

1.7.12 Lithium Battery: A CR2450, 3.0-volt lithium coin battery powers the CMS-4. The battery icon in the upper right of the LCD shows remaining battery life. When the CMS-4 detects a low battery voltage, a low battery warning is activated. When battery power is too low for Measuring Mode, the CMS-4 sounds a dead battery alarm. (Gas reading disappears, **FAIL** appears in the middle of the screen, **BATTERY** appears at the bottom of the screen, LEDs flash once per second, and audible alarm double pulses once per second.)

A spare battery is provided with the monitor; refer to Section 6.1 for instructions on replacing the battery.

2.0 SETUP – INSTALLATION, STARTUP AND OPERATION

2.1 Installation

This section explains the initial installation of the CMS-4 to the inside of the respirator.

2.1.1 Prepare Mounting Clip

2.1.1.1 Adhere Velcro® loop to CMS-4 mounting clip: Trim the Velcro® loop strip to 3/4" x 1". Remove the backing and adhere it to the bottom of the monitors mounting clip, as shown in Figure 4.

2.1.2 Installing Monitor in Apollo 20 Respirator

Refer to Section 2.1.3 for installing the monitor in Apollo 60 and Apollo 600 respirators.

2.1.2.1 If not already done, adhere the Velcro® loop to CMS-4 mounting clip, per Section 2.1.1.

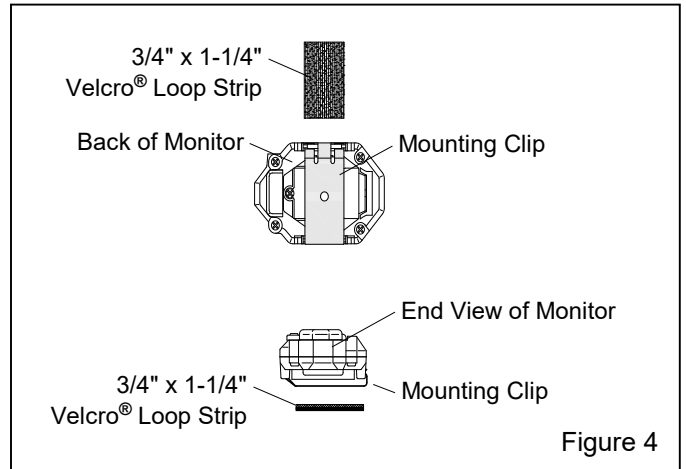

Figure 4

2.1.2.2 Open the lens frame and remove the lenses.

2.1.2.3 Don (put on) the helmet and temporarily place the monitor on one of the side walls of the window extension, as shown in Figure 5. Make sure the monitor's LED lights are visible.

2.1.2.4 Mark the location and remove the monitor and helmet.

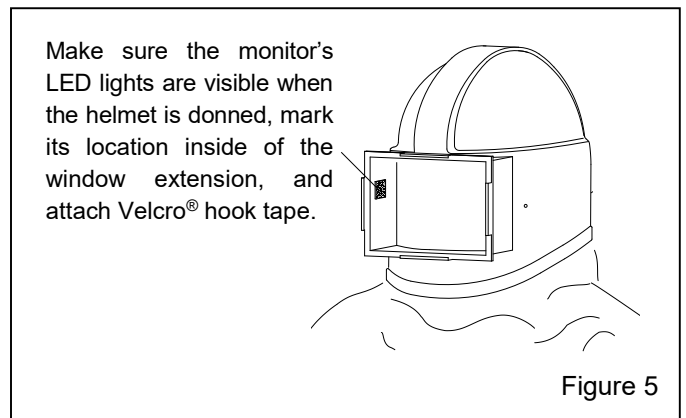

Figure 5

2.1.2.5 Remove backing from the Velcro® hook tape and adhere it at the marked location (the loop tape adheres to the mounting clip on the monitor). Use the Velcro® to attach the monitor to the hood, positioning it so the control buttons face toward lenses and alarm-lights toward the inside of the respirator. Don the helmet to make sure the monitor's alarm-lights are visible from inside the helmet.

2.1.2.6 Remove the monitor and prepare it for operation, per Section 2.2.

2.1.2.7 Replace the lenses and lens frame assembly.

2.1.2.8 After the initial setup is done, remove and reattach the monitor using the Velcro®. **Remove the**

monitor when doffing (taking off) the respirator at the end of the shift and to do any service or calibration, including turning the monitor on and off.

Do this to make sure the monitor is fully functional before placing it inside the helmet.

⚠ WARNING

Remove the monitor at the end of the shift, turn it off, and store it in a clean environment. At the beginning of each shift, turn on the monitor and make sure it is fully functional before installing it in the helmet. Failure to do so could result in CO poisoning and death.

2.1.3 Installing Monitor in Apollo 60 and Apollo 600 Respirators

Refer to Section 2.1.2 for mounting the monitor in Apollo 20 respirators.

2.1.3.1 If not already done, adhere the Velcro® loop to CMS-4 mounting clip, per Section 2.1.1.

2.1.3.2 Place the transparent mounting strip on the inside of the inner lens, and into the same window gasket groove as the inner lens, as shown in Figure 6. Position it so it is within peripheral vision toward the side of the window opening.

As seen from inside the hood, the strip is inserted into the groove in the window gasket. Attach Velcro® hook tape to the inside of the strip. Make sure the monitor's LED lights are visible when the helmet is donned.

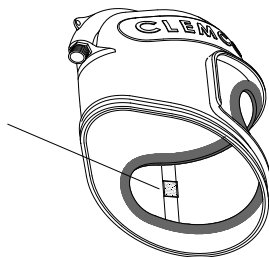

Figure 6

2.1.3.3 Remove backing from the Velcro® hook tape and adhere it to the mounting strip (the loop tape adheres to the mounting clip on the monitor) making sure the LED lights are visible from inside the helmet.

2.1.3.4 Attach the monitor to the strip, positioned so the buttons face toward the outer edge of the window opening and LED lights toward the center of the window opening. Don (put on) the helmet to make sure the monitor LED lights are visible from inside the helmet.

2.1.3.5 Remove the monitor and prepare it for operation.

2.1.3.6 After the initial setup is done, remove and reattach the monitor from inside the helmet. **Remove the monitor when doffing the respirator at the end of the shift and to do any service or calibration, including turning the monitor on and off.** Do this to make sure the monitor is fully functional before placing it inside the helmet.

⚠ WARNING

Remove the monitor at the end of the shift, turn it off, and store it in a clean environment. At the beginning of each shift, turn on the monitor and make sure it is fully functional before installing it in the helmet. Failure to do so could result in CO poisoning and death.

2.2 Turning ON and Startup Procedure

This section explains how to startup the CMS-4 and to prepare it for operation.

2.2.1 Press and hold the POWER/MODE button until the alarm beeps.

2.2.2 The monitor goes through the warm-up sequence: all LCD segments turn on, backlight turns on, and instrument beeps and vibrates. It then cycles through calibration status, date/time, remaining battery life, target gas, and alarm setpoint screens.

2.2.3 After the warm-up sequence, the monitor goes into Measuring Mode (normal operating mode). It beeps, the LCD screen (as shown in Figure 8) shows CO, remaining battery life, a pulsing heart symbol (indicating the monitor is in normal operating status), CO concentrations (ppm), and the date and time (when set per Section 2.3).

⚠ WARNING

If the monitor is in low battery warning, change the battery as soon as possible. Do not use the respirator if the dead battery warning is alarmed. The monitor does not detect carbon monoxide when it is in dead battery alarm, which can result in death if carbon monoxide is present.

2.3 Setting the Date and Time – Figure 7

NOTE: When using the CMS-4 for the first time, check the current time and verify that it is correct for your time zone. If it is not, set the time as follows:

2.3.1 With the instrument turned OFF, press and hold AIR and POWER MODE. Release when you hear a beep. *BUMP* is displayed.

2.3.2 Press and release the AIR button to scroll to DATE.

2.3.3 Press and release POWER/MODE. The date and time will be displayed with the year flashing.

2.3.4 Use AIR to display the desired year. To reverse the direction of change (i.e. from increasing to decreasing or vice versa):

- Press and hold AIR.
- Immediately press POWER/MODE and then release both buttons.

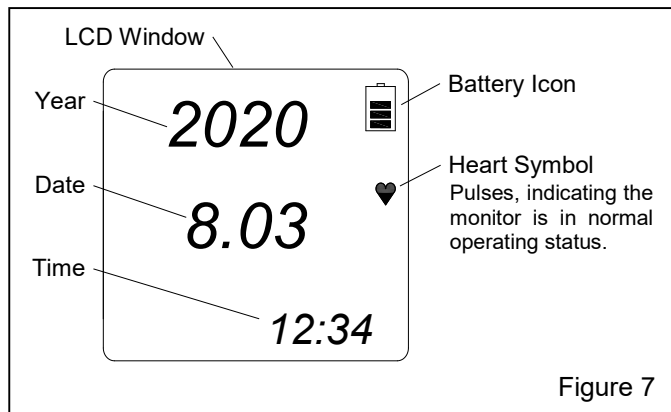

2.3.5 Press POWER MODE to save it. The month starts to flash.

2.3.6 Use AIR to adjust the month. Press POWER MODE to save it. The day starts to flash.

2.3.7 Repeat the process to set the day, hour, and minute. The time is shown in military format with the hour going from 0 to 24.

2.3.8 Use AIR to scroll to START. Press and release POWER MODE to begin the warm-up sequence. **NOTE:** If no button is pressed within 20 seconds, the monitor will automatically return to measuring mode.

2.4 Performing a Fresh-Air Adjustment

NOTE: Before using the CMS-4, set the fresh-air baseline to ensure accurate gas readings.

Additional fresh-air adjustment information is in Section 5.2.

2.4.1 Make sure the monitor is in a fresh-air environment. This is an environment free of toxic or combustible gases and of normal oxygen content (20.9%).

2.4.2 Turn on the monitor by pressing and holding the POWER/MODE button until the alarm beeps.

2.4.3 The monitor goes through the warm-up sequence, as noted in Paragraph 2.2.2.

2.4.4 After the warm-up sequence, the monitor goes into Measuring Mode (normal operating mode), it beeps, and the LCD display is as shown in Figure 8.

2.4.5 Press and hold the AIR button. While pressing the AIR button, the LCD displays *HOLD*, a prompt to keep pressing the AIR button.

2.4.6 When the fresh-air baseline has been set, the LCD displays Adj, and a prompt to *RELEASE* the AIR button. The monitor beeps once and the screen displays 0 ppm, as shown in Figure 8.

2.4.7 The monitor is now in Measuring Mode (normal operation). After an initial calibration per Section 5.7, the CMS-4 is ready for monitoring.

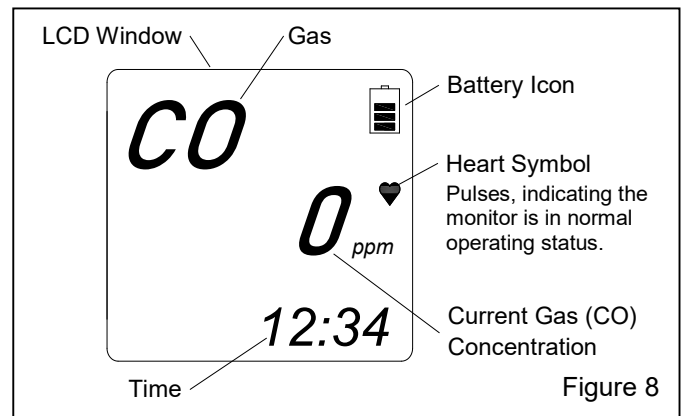

2.5 Turning OFF the CMS-4

2.5.1 Remove the monitor after doffing (taking off) the respirator at the end of the shift.

2.5.2 Press and hold the POWER/MODE button.

2.5.3 OFF will appear on the screen and the monitor will beep for about five seconds. Release the button when OFF disappears from the screen and the LCD is blank. The monitor is off.

3.0 Alarms

This section covers alarm indications. It also explains how to respond to an alarm condition and how to reset the CMS-4 after an alarm has occurred.

3.1 Alarm Indications

3.1.1 Audible Alarms

- Gas Alarms: Alternating high-low tone – chirps occur about once per second.
- Fault Alarms: Double-pulsing beep occurring about once per second.

In addition to the audible alarms, the monitor vibrates, and the LEDs flash when any sort of alarm condition or failure is encountered.

3.2 Alarm Indications Table: Refer to table in Figure 9 on the following page for Alarm Type, Visual Indications, and other alarm indications

3.3 Resetting the Monitor After an Alarm

3.3.1 The CMS-4 remains in alarm until the alarm conditions pass and POWER/MODE is pressed.

NOTE: Even though the gas concentration may have fallen below the alarm point, the alarm indications will continue until the alarm is reset using the POWER/MODE button, as noted in the paragraph below. A *PEAK* alarm display cannot be cleared until the monitor is turned OFF. If a *TWA* or *STEL* alarm has been activated, it cannot be reset unless the monitor is turned OFF.

3.3.2 To reset a CO gas alarm, after the CO reading falls below the low-alarm point (10 ppm), press and release the POWER/MODE button once.

3.4 Responding to Alarms

This section describes responses to gas, over range, battery, sensor failure, clock failure, and system failure alarms.

3.4.1 Responding to CO Alarms

3.4.1.1 Follow an established procedure for responding to CO gas alarms. It should include but not be limited to removing the respirator as soon as it is safe to do so.

3.4.1.2 Reset the alarm by pressing and releasing the POWER/MODE button once after the CO reading falls below the low alarm point.

3.4.2 Responding to an Over Range Alarm

An over range alarm could indicate CO gas is above the detection limit of 1000 ppm. The CO concentration reading is replaced by blinking brackets (ΠΠΠΠ).

WARNING

An over range condition may indicate an extreme CO concentration. Remove the respirator as quickly as possible when it is safe to do so.

3.4.2.1 Follow an established procedure for responding to CO gas alarms. It should include but not be limited to removing the respirator as soon as it is safe to do so.

3.4.2.2 Reset the alarm using POWER/MODE once the alarm condition has cleared.

3.4.2.3 Calibrate the CMS-4, as described in Section 5.7.

3.4.2.4 If the **Over Range** condition continues, the sensor may need to be replaced.

3.4.2.5 If the **Over Range** condition continues after replacing the sensor, contact the authorized Clemco distributor the monitor was purchased through for further instructions.

3.4.3 Responding to Battery Alarms

WARNING

The CMS-4 is not operational during a dead battery alarm. Do not use the respirator until the battery is replaced. Breathing compressed air while a monitor is not operational can result in death if carbon monoxide is present.

3.4.3.1 The CMS-4 is fully functional during a low battery warning. However, only a limited amount of operating time remains. The amount of time depends on how often the LCD backlight is used and how often the monitor responds to alarm conditions. Replace the battery as soon as possible when a low battery warning occurs. *Refer to Section 6.1: Replacing the Lithium Battery.*

NOTE: Alarms and the LCD backlight consume battery power and reduce the amount of operating time remaining.

ALARM TYPES AND INDICATIONS		
ALARM TYPE	VISUAL INDICATIONS	OTHER ALARM INDICATIONS
<p>WARNING <i>Concentration of CO rises above the Warning setting (10 ppm).</i></p>	<ul style="list-style-type: none"> • Gas reading flashes. • Warning appears at the bottom of the LCD. • Alarm LEDs flash. • Backlight turns on. 	<ul style="list-style-type: none"> • Alternating high-low tone – chirps about twice per second. • Vibrator pulses once per second.
<p>Alarm <i>Concentration of CO rises above alarm setting of 10 ppm.</i></p>	<ul style="list-style-type: none"> • Gas reading flashes. • Alarm appears at the bottom of the LCD. • Alarm LEDs flash. • Backlight turns on. 	<ul style="list-style-type: none"> • Alternating high-low tone – chirps about twice per second. • Vibrator pulses once per second.
<p>ALARM H <i>Concentration of CO rises above the high alarm setting of 10 ppm.</i></p>	<ul style="list-style-type: none"> • Gas reading flashes. • ALARM H appears at the bottom of the LCD. • Alarm LEDs flash. • Backlight turns on. 	<ul style="list-style-type: none"> • Alternating high-low tone – chirps about twice per second. • Vibrator pulses once per second.
<p>TWA or STEL <i>Concentration of CO rises above the TWA or STEL alarm setting.</i></p>	<ul style="list-style-type: none"> • Gas reading flashes. • TWA or STEL appears at the bottom of the LCD. • Alarm LEDs flash once per second. • Backlight turns on. 	<ul style="list-style-type: none"> • Alternating high-low tone – chirps about twice per second. • Vibrator pulses once per second.
<p>Over Range <i>An over range condition indicates an extreme CO concentration.</i></p>	<ul style="list-style-type: none"> • Gas reading is replaced with a flashing ПППП. • Gas name and units flash. • OVER appears at the bottom of the LCD. • Alarm LEDs flash twice per second. • Backlight turns on. 	<ul style="list-style-type: none"> • Alternating high-low tone – chirps about twice per second. • Vibrator pulses once per second.
<p>Low Battery Warning</p>	<ul style="list-style-type: none"> • The last bar in the battery icon disappears and the battery icon starts flashing. 	<ul style="list-style-type: none"> • None.
<p>Dead Battery Alarm</p>	<ul style="list-style-type: none"> • Alarm LEDs flash once per second. • Gas reading disappears. • FAIL appears in the middle of the screen and BATTERY appears at the bottom of the screen. • Alarm LEDs flash once per second 	<ul style="list-style-type: none"> • Double pulsing beep occurring about once per second
<p>Sensor Failure</p>	<ul style="list-style-type: none"> • FAIL appears in the middle of the screen and SENSOR appears at the bottom of the screen. • Alarm LEDs flash once per second. 	<ul style="list-style-type: none"> • Double pulsing beep occurring about once per second.
<p>System Failure</p>	<ul style="list-style-type: none"> • Gas reading replaced by FAIL. • Time replaced by SYS below FAIL. 	<ul style="list-style-type: none"> • Double pulsing beep occurring about once per second.
<p>Clock Failure</p>	<ul style="list-style-type: none"> • FAIL 050 CLOCK appears on the screen. • Alarm LEDs flash once per second. 	<ul style="list-style-type: none"> • Double pulsing beep occurring about once per second.

Figure 9

3.4.4 Responding to a Sensor Failure Alarm

3.4.4.1 Perform a calibration, as described in Section 5.7.

3.4.4.2 If the sensor failure alarm continues, replace the sensor, as described in Section 6.2.

3.4.4.3 If the sensor failure alarm continues after replacing the sensor, contact the authorized Clemco distributor the monitor was purchased through for further instructions.

3.4.5 Responding to Clock Failure Alarm – Figure 10

A clock failure alarm occurs if the monitor's internal clock malfunctions.

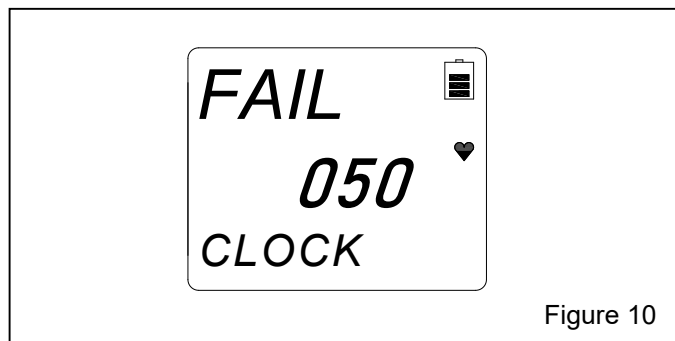

Figure 10

3.4.5.1 If the error code is 050, press and release POWER/MODE to continue into Measuring Mode if the instrument must be used temporarily.

3.4.5.2 Attempt to set the date using the DATE menu item in User Mode. Refer to Section 2.3: *Setting Date and Time*.

3.4.5.3 If the date cannot be set correctly, contact the authorized Clemco distributor the monitor was purchased through for further instructions.

3.4.6 Responding to a System Failure Alarm

3.4.6.1 If a system failure occurs, the system failure screen will display an error code similar to that shown in Figure 11.

3.4.6.2 If the System Failure error code is anything but 031, as shown in Figure 11, the instrument cannot be used. Contact Clemco Industries as soon as possible. If the error code is 031, press and release POWER/MODE to continue into Measuring Mode if the instrument must be used temporarily.

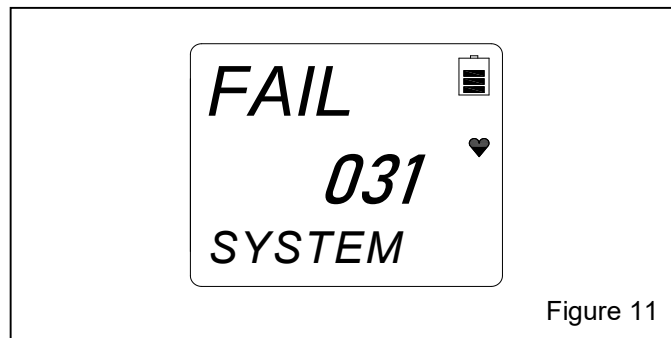

Figure 11

3.5 Alarm Setpoints

3.5.1 There are six alarm points. The alarm points and their factory settings are summarized below. Refer to Section 3.6.1 to change the alarm setpoints to 5 ppm, refer to Section 3.1.2 to return the alarm 10 ppm.

- ***F. S. (Full Scale):** Is triggered when CO concentrations go over the scale maximum of 1000 ppm.
- **WARNING:** Is triggered when CO concentrations reach 10 ppm, which is the maximum exposure limit for Grade D compressed air in the United States. Refer to Section 3.6 to change alarm setpoints.
- **Alarm:** Is triggered when CO concentrations reach 10 ppm. Refer to Section 3.6 to change alarm setpoints.
- **Alarm H:** Because the maximum exposure limit for grade D breathing air in the U.S.A. is 10 ppm of CO, the high alarm is also set to alarm when CO concentration reaches 10 ppm. This alarm is a rapid, twice per second beep and stresses the urgency to remove the respirator as soon as it is safe to do so.
- ***TWA Alarm:** TWA is an acronym for time-weighted average; it is the average reading of CO during the last eight hours. The alarm triggers when TWA reaches 25 ppm
- ***STEL Alarm:** STEL is an acronym for short-term exposure limit; it is the average reading of CO during the last 15 minutes. The alarm triggers when STEL reaches 200 ppm

* Although some may find Full Scale, TWA and STEL information useful, it is not relevant for supplied-air respirator use because the maximum exposure limit for Grade D breathing air is 10 ppm.

3.6 Changing Alarm Setpoints

3.6.1 Change alarm setpoints to 5 ppm

3.6.1.1 Begin with the monitor OFF. Press and hold the POWER/MODE button. Release the button when the alarm stops beeping and the screen goes blank.

3.6.1.2 Press and hold the AIR button, then press and hold the POWER/MODE button. Release both buttons as soon as the monitor beeps. *BUMP* should appear at the bottom of the display.

NOTE: If at any time during the operation the operator makes a mistake or is otherwise stuck, refer to Section 4.4.3: *Return to Factory Default Settings*. After returning to factory default settings, repeat the process as noted to change alarm setpoints.

3.6.1.3 Press and release the AIR button 4 times (4 beeps). *ALARM-P* appears in the display.

3.6.1.4 Press and release the POWER/MODE button 2 times until *WARNING* appears at the bottom of the display and 10 ppm warning setpoint flashes.

3.6.1.5 Press and release the AIR button once; 5 ppm flashes. Press and release the POWER/MODE button once to accept the change.

3.6.1.6 *ALARM* appears at the bottom of the display and 10 ppm setpoint flashes.

3.6.1.7 Press and release the AIR button once; 5 ppm flashes. Press and release the POWER/MODE button once to accept the change.

3.6.1.8 *ALARM H* appears at the bottom of the display and the *ALARM H* setpoint flashes 10 ppm.

3.6.1.9 Press and release the AIR button until 5 ppm flashes. **NOTE:** If the setpoint increases when the AIR is pressed, reverse the scroll direction by:

1. Press and hold AIR.
2. Immediately press POWER/MODE and then release both buttons. Press and release the AIR button until 5 ppm flashes.

3.6.1.10 Press and release the POWER/MODE button once to accept the change.

3.6.1.11 Press the POWER/MODE button 2 times to scroll through *STEL* and *TWA*. *END* should appear and then disappear within a few seconds. *ALARM P* should appear at the bottom of the display.

3.6.1.12 Turn the monitor off by pressing and holding the POWER/MODE button until the alarm stops beeping and the screen goes blank.

3.6.1.13 Turn the monitor on by pressing and holding the POWER/MODE button until it beeps once. 5 ppm setpoints are briefly displayed as the monitor goes through the warm-up sequence.

3.6.1.14 The monitor now is in Measuring Mode (normal operating mode).

3.6.2 Change alarm setpoints to 10 ppm

3.6.2.1 Begin with the monitor OFF. Press and hold the POWER/MODE button. Release the button when the alarm stops beeping and the screen goes blank.

3.6.2.2 Press and hold the AIR button, then press and hold the POWER/MODE button. Release both buttons as soon as the monitor beeps. *BUMP* should appear at the bottom of the display.

NOTE: If at any time during the operation the operator makes a mistake or is otherwise stuck, refer to Section 4.4.3: *Return to Factory Default Settings*. After returning to factory default settings, repeat the process as noted to change alarm setpoints.

3.6.2.3 Press and release the AIR button 4 times (4 beeps). *ALARM-P* appears in the display.

3.6.2.4 Press and release the POWER/MODE button 4 times until *ALARM H* appears at the bottom of the display and current setpoint flashes.

3.6.2.5 Press and release the AIR button until 10 ppm flashes. Press the POWER/MODE button once to accept the change.

3.6.2.6 Press and release the POWER/MODE button 2 times. Off will briefly appear and then disappear.

3.6.2.7 When *ALARM P* reappears, press and release the POWER/MODE button 2 times.

3.6.2.8 *ALARM* appears at the bottom of the display and the alarm setpoint flashes.

3.6.2.9 Press and release the AIR button until 10 ppm flashes. Press the POWER/MODE button once to accept the change.

3.6.2.10 Press and release the POWER/MODE button 3 times. *OFF* briefly appear and then disappear.

3.6.2.11 When *ALARM P* reappears, Press and release the POWER/MODE button once. *WARNING* appears at the bottom of the display and the alarm setpoint flashes.

6.6.2.12 Press and release the AIR button until 10 ppm flashes. Press the POWER/MODE button once to accept the change.

3.6.2.13 Press and release the POWER/MODE button 4 times to scroll through *ALARM*, *ALARM H*, *STEL* and *TWA*. *END* should appear and then disappear within a few seconds. *ALARM P* should appear at the bottom of the display.

3.6.2.14 Press and hold the POWER/MODE button to turn the monitor off. Release the button when the alarm stops beeping and the screen goes blank.

3.6.2.15 Turn the monitor on by pressing and holding the POWER/MODE button until it beeps once. 10 ppm setpoints are briefly displayed as the monitor goes through the warm-up sequence.

3.6.2.16 The monitor now is in Measuring Mode (normal operating mode).

4.0 MANEUVERING THROUGH MENU MODES

This section helps the user maneuver through CMS-4 menu items. The menu item under each mode is listed in sequential order.

4.1 MEASURING MODE – Measuring Mode is the normal operating mode used to detect CO and observe any alarm indications. The monitor must be in measuring mode before it is placed in the respirator.

⚠ WARNING

The CMS-4 is not operational as a carbon monoxide monitor unless it is Measuring Mode. The monitor must be in Measuring Mode before it is placed in the respirator. Failure to ensure the monitor is in Measuring Mode can result in death if carbon monoxide is present.

4.1.1 Entering Measuring Mode

4.1.1.1 Make sure the monitor is OFF. (Press and hold POWER/MODE until the screen is blank.)

4.1.1.2 Turn on the monitor by pressing and holding the POWER/MODE button until the alarm beeps.

4.1.1.3 After the warm-up sequence, the monitor goes into Measuring Mode (normal operating mode) when the alarm beeps and the LCD screen is as shown in Figure 12 and indicates the current gas concentration. **NOTE: The gas concentration shown in the illustration is for reference only. The number displayed on the LCD**

will be the actual CO gas reading. After an initial calibration per Section 5.7, the CMS-4 is ready for monitoring.

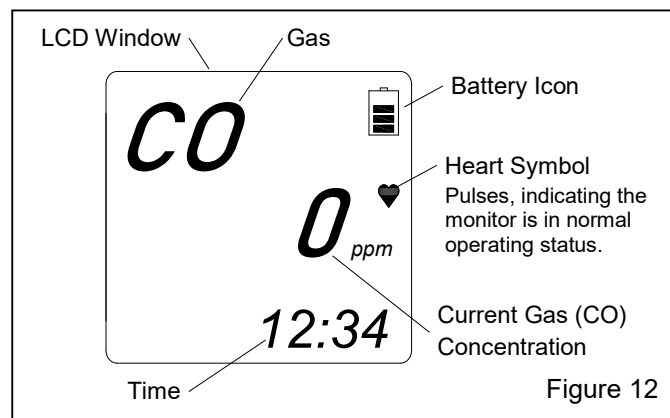

4.2 USER MODE – User Mode is used to do bump tests, calibrate the monitor, and make minor screen adjustments used primarily to calibrate the monitor.

⚠ WARNING

The CMS-4 is not operational as a carbon monoxide monitor while in User Mode. The monitor must be in Measuring Mode before it is placed in the respirator. Failure to ensure the monitor is in Measuring Mode can result in death from carbon monoxide poisoning.

4.2.1 Entering User Mode

Begin with the monitor OFF.

4.2.1.1 Press and hold the AIR button, then press and hold the POWER/MODE button. Release both buttons as soon as the monitor beeps.

4.2.2 Tips for Using User Mode

- To scroll from one menu item to the next, press AIR and release it as soon as the alarm beeps.
- To reverse the scroll direction:
 1. Press and hold AIR.
 2. Immediately press POWER/MODE and then release both buttons.

4.2.3 To cycle through each of the user mode menus, press POWER/MODE and release it as soon as the alarm beeps

4.2.4 The first screen to appear will be *BUMP*, as shown in Figure 13.

4.2.5 To scroll to the next menu item (GAS CAL), press and release POWER/MODE. Continue to press and release POWER/MODE to scroll through every menu item.

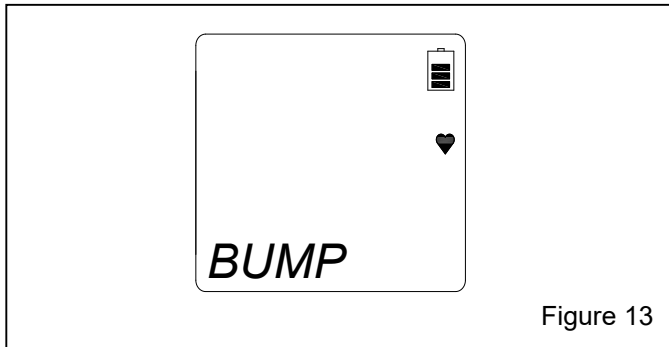

Figure 13

Refer to Section 5.6 to perform a bump test.

4.2.6 Refer to the table in Figure 14 on the following page for a sequential list of the items found in User Mode, the page that the menu item's instructions can be found on, and a short description of the menu item.

4.2.7 Display Firmware Version.

4.2.7.1 Enter User Mode, per Section 4.2.1.

4.2.7.2 Press and release AIR and scroll to ROM/SUM.

4.2.7.3 Press and release POWER/MODE. The screen will cycle through the boards and display the ROM as the top value and SUM as the bottom value.

SEQUENTIAL LIST OF USER MODE MENU ITEMS			
Number of Times POWER/MODE (beeps) is pressed and released to reach menu item.	User Mode Menu Items	Description	Section in Which Adjustments are Found
ONE	<i>BUMP</i>	Perform bump test.	Refer to Section 5.6.
TWO	<i>GAS CAL</i>	Perform a calibration.	Refer to Section 5.7.
THREE	<i>CAL SET</i>	Changes parameters related to calibration.	No adjustment required. Do not adjust.
FOUR	<i>BUMP SET</i>	Changes setting related to bump testing.	No adjustment required. Do not adjust.
FIVE	<i>ALARM-P</i>	Change alarm setpoints.	Refer to Section 3.6.
SIX	<i>LUNCH</i>	Resets <i>TWA</i> and <i>STEL</i> readings at startup.	No adjustment required. Do not adjust.
SEVEN	<i>BEEP</i>	Sets confirmation beep parameters.	No adjustment required. Do not adjust.
EIGHT	<i>BL TIME</i>	How long backlight stays on.	No adjustment required. Do not adjust.
NINE	<i>KEY.TONE</i>	Sets whether or not alarm beeps when button is pressed.	Factory setting is ON. Do not adjust.
TEN	<i>DISP.SET</i>	Sets user ID, Station ID, and Alarm Volume.	Factory setting is ON. Do not adjust.
ELEVEN	<i>E-CAL</i>	<i>A-CAL</i> item appears in <i>GAS CAL</i> menu. <i>E-CAL</i> . Factory setting is OFF.	Factory setting is OFF. Do not adjust.
TWELVE	<i>DATE</i>	Sets the <i>Date</i> and <i>Time</i> .	Refer to Section 2.3.
THIRTEEN	<i>PASS W</i>	When set to ON, password required to enter User Mode.	Factory setting is OFF. Do not adjust.
FOURTEEN	<i>ROM/SUM</i>	Shows firmware version and firmware checksum.	Refer to Section 4.2.7 to display firmware.
FIFTEEN	<i>START</i>	Enters Measuring Mode from User Mode.	Press and release POWER/MODE.

Figure 14

4.3 DISPLAY MODE – Display mode is used to view and change settings of menu items noted in the table in Figure 15. Refer to the table for a list of the items found in Display Mode, a short description of the menu item’s function, and the section that the menu item’s instructions can be found.

⚠ WARNING

The CMS-4 is not operational as a carbon monoxide monitor while in Display Mode. The monitor must be in Measuring Mode before it is placed in the respirator. Failure to ensure the monitor is in Measuring Mode can result in death from carbon monoxide poisoning.

4.3.1 Entering Display Mode

4.3.1.1 Enter Display Mode using one of the two following methods:

1. From Measuring Mode (normal operating mode) press POWER/MODE and release it as soon as the alarm beeps. The monitor is now in Display Mode.
2. If the monitor is OFF:
 - 1) Press and hold POWER/MODE until the alarm beeps.
 - 2) After the warm-up sequence, the monitor goes into Measuring Mode (normal operating mode). It beeps, the LCD screen (as shown in Figure 12) shows CO, remaining battery life, a pulsing heart symbol (indicating the monitor is in normal operating status), CO concentrations (ppm), and the date and time (when set per Section 2.3). *Review Section 2.2: Turning On and Startup Procedure.*
 - 3) From Measuring Mode (normal operating mode), press POWER/MODE and release it as soon as the alarm beeps. The monitor is now in Display Mode.

4.3.2 Tips for Using Display Mode

- To scroll from one menu item to the next, press POWER/MODE and release it as soon as the alarm beeps.

SEQUENTIAL LIST OF DISPLAY MODE MENU ITEMS

Number of times POWER/MODE (beeps) is pressed and released to reach menu item.	Display Mode Menu Items	Description	Sections In Which Adjustments Are Found
ONE	PEAK	Displays peak (highest) CO concentration since the monitor was last turned on.	No adjustment required. Do not adjust.
TWO	STEL	Displays short-term exposure limit. This reading is the average reading over the last 15 minutes.	No adjustment required. Do not adjust.
THREE	TWA	Displays time-weighted average over the last 8 hours.	No adjustment required. Do not adjust.
FOUR	DISP (CAL DATA LCD screen cycles through CAL.DATA, YES/AIR, and NO/MODE.	Shows date of last calibration. Factory set to ON.	No adjustment required. Do not adjust.
FIVE	DATE and TIME	Displays Year, Date, and Time.	Set per Section 2.3.
SIX	TEMP	Displays ambient temperature in Celsius.	Not adjustable.
SEVEN	DISP (ALARM-P LCD screen cycles through ALARM-P, YES/AIR, and NO/MODE	View alarm setpoints.	No adjustment required. Do not adjust.
EIGHT	HI (Alarm Beep Volume)	Sets the buzzer volume. <i>Factory set to high.</i>	No adjustment required. Do not adjust.
NINE	Returns to measuring mode.		

Figure 15

- To enter an item, press and release AIR.
- To reverse the direction of a flashing parameter, (i.e. from increasing to decreasing or vice versa):
 - 1) Press and hold AIR.
 - 2) Immediately press POWER/MODE and then release both buttons.

NOTE: Each screen displays for 20 seconds. If a button is not pressed within 20 seconds, the CMS-4 automatically returns to Measuring Mode.

4.3.3 To cycle through each of the following display mode menus, press POWER/MODE and release it as soon as the alarm beeps. Refer to the Table in Figure 15 for additional information.

4.3.4 DISPLAY MODE MENU ITEMS (Reference Table in Figure 15)

Menu items shown with "No Adjustment" have factory settings that should not be adjusted. DO NOT PUSH BUTTONS THAT CAN CHANGE THE MONITOR'S FUNCTION. If the operator accidentally enters an unfamiliar menu, refer to Section 4.4 to return to factory settings.

4.3.5 Displaying the PEAK Screen

4.3.5.1 The PEAK screen displays the highest CO concentration detected since the CMS-4 was turned ON. The PEAK reading is stored until a higher level is detected, the PEAK reading is cleared, or the CMS-4 is turned OFF.

4.3.5.2 PEAK readings are automatically cleared when the monitor is turned OFF or cleared (as noted beginning with Paragraph 4.3.5.3), and restarted when the monitor is turned ON.

4.3.5.3 Make sure the monitor is in Display Mode, as noted in Section 4.3.1.

4.3.5.4 Press and release POWER/MODE until PEAK appears in the lower-left corner of the LCD screen, as shown in Figure 16.

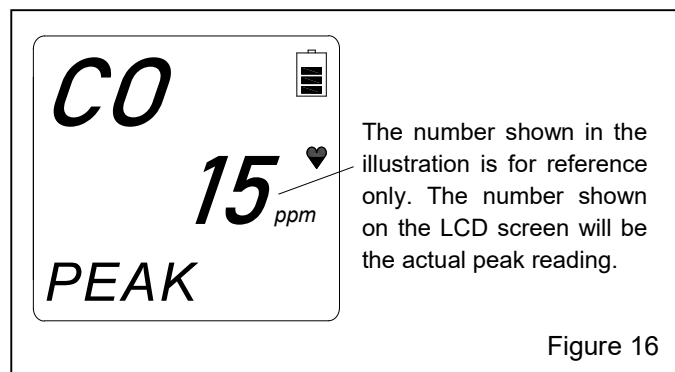

4.3.5.5 To clear the peak reading, do the following while remaining in Display Mode:

1. While PEAK appears on the screen, press AIR and hold (as shown in the left image in Figure 17), and release it when prompted (as shown in right image).
2. The peak reading will be reset and the display will return to the PEAK Screen.
3. After 20 seconds, the monitor will return to Measuring Mode.

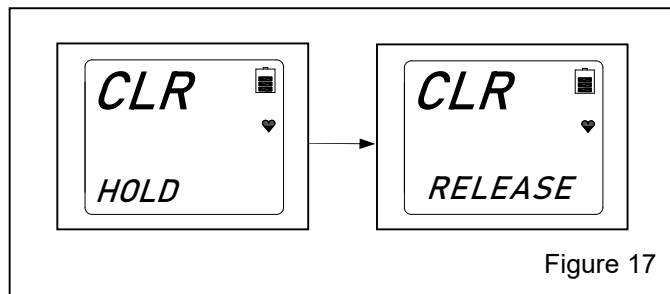

4.3.6 Displaying the STEL Screen – Figure 18

4.3.6.1 The STEL Screen displays the short-term exposure limit (STEL) reading. The STEL reading is the average reading over the last 15 minutes. *There are no changes or resets on the STEL menu.*

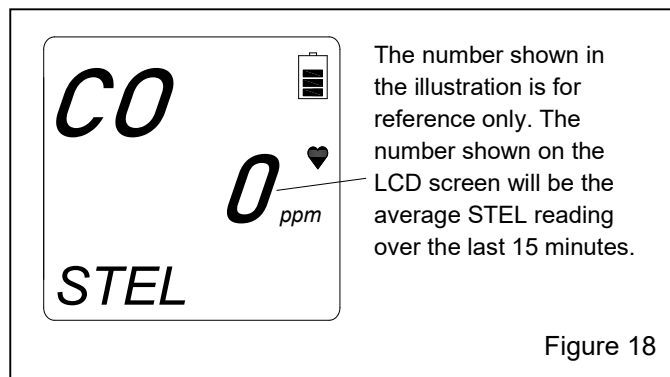

4.3.7 Displaying the TWA Screen

4.3.7.1 The TWA Screen displays the time-weighted average (TWA) reading. The TWA reading is the average reading over the last 8 hours. If 8 hours have not elapsed since the last time the TWA reading was cleared, the average is still calculated over 8 hours. The missing readings are assigned a value of 0.

4.3.8 TWA readings are automatically cleared when the monitor is turned OFF and begins collecting new TWA readings when the monitor is turned ON.

4.4 MAINTENANCE MODE

NOTE: Maintenance Mode Changes settings that operationally affect the instrument.

⚠ WARNING

Maintenance Mode settings affect the operation of the monitor and should only be cautiously changed. Changing settings on an impulse can lead to false or no alarms, resulting in carbon monoxide poisoning, death, or serious injury.

4.4.1 Return to Factory Default Settings: The only function we advise using in Maintenance Mode is to default to factory settings when menu items have been unintentionally changed. These changes are identified when menu items on the screen do not match menu items in the instructions.

4.4.2 Entering Maintenance Mode

⚠ WARNING

The CMS-4 is not operational as a carbon monoxide monitor while in Maintenance Mode. The monitor must be in Measuring Mode before it is placed in the respirator. Failure to ensure the monitor is in Measuring Mode can result in death if carbon monoxide is present.

4.4.2.1 Make sure the monitor is OFF. (Press and hold POWER/MODE until the screen is blank.)

4.4.2.2 Press and hold AIR, then press and hold POWER/MODE. Continue to hold the buttons down after the first beep.

4.4.2.3 Release both buttons after the second beep. The LCD screen should be as shown in Figure 19 with the digit on the left flashing.

4.4.2.4 The factory-set password is 3000.

4.4.2.5 Enter the password by using AIR to select each password number and then press and release POWER/MODE to save it and move on to the next number until all of the numbers are entered. To reverse the direction of change (i.e. from increasing to decreasing or vice versa):

1. Press and hold AIR.
2. Immediately press POWER/MODE and then release both buttons.

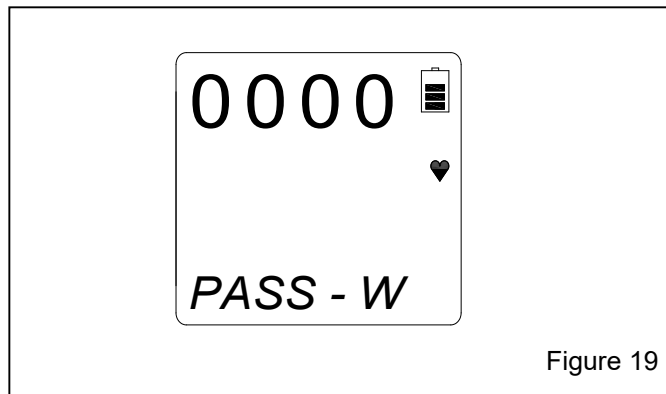

Figure 19

4.4.3 Performing a Default (M.DEF)

NOTE: Performing a default operation in Maintenance Mode returns all parameters to their factory settings.

4.4.3.1 Enter Maintenance Mode, per Section 4.4.2.

4.4.3.2 Press and release AIR 16 times and scroll to M.DEF.

4.4.3.3 Press and release POWER/MODE. The screen will alternate between M.DEF, YES.MODE, and NO.AIR.

4.4.3.4 Press and release POWER/MODE to perform a default operation.

4.4.3.5 The monitor will ask if you are sure you want to perform a default operation by alternating between SURE?, YES.MODE, and NO.AIR.

4.4.3.6 Press and release POWER/MODE. The monitor will beep twice, briefly display PASS, and return to M-DEF.

4.4.3.7 To return to Measuring Mode (normal operating mode), press and release AIR once and press and release POWER/MODE. The monitor will begin the warm-up sequence and enter measuring mode.

5.0 CALIBRATION, FRESH-AIR ADJUSTMENTS, BUMP TEST, and STORAGE

This section covers:

- Calibration Schedule
- Performing Fresh-Air Adjustments
 - a) Setting the adjustment with ambient air.
 - b) Setting the adjustment with impurity-free test gas.
- Prepare Calibration Connector for Calibration.
- Connect Calibration Cup to Monitor
- Remove Calibration Cup from Monitor
- Performing a Bump Test

- Calibrating the CMS-4
- Storing the Calibration Connector and Test Gas

⚠ WARNING

Use a 0.5 LPM (liters per minute) fixed-flow, calibration-connector regulator valve (Clemco Stock No. 25572) when calibrating. Use of a different flow rate will adversely affect the accuracy of the calibration.

5.1 Calibration Schedule

5.1.1 Once the date and time are set, per Section 2.3, the monitor displays a reminder that a bump test and/or calibration are due. Factory setting are:

- Bump test reminder is set for 30 days.
- Calibration reminder is set for 90 days.

Initial Calibration Schedule: To become familiar with the operation and settings of the monitor the following initial schedule should be observed:

- Do a bump test daily for the first week of operation. Refer to Section 5.6.
- Calibrate weekly for the first month of operation. Refer to Section 5.7.
- Follow bump test and calibration reminder schedules thereafter.
- Bump test before use if the monitor was out of service for more than one week.

5.2 Performing Fresh-Air Adjustments

Fresh-air adjustments must be done in a fresh-air environment, free of toxic or combustible gases and with normal oxygen content (20.9%). The usual method is to set it in fresh ambient air. **If fresh, ambient air cannot be assured, set the fresh-air baseline with impurity-free (0 ppm) test gas, as described in Section 5.2.2.**

5.2.1 Fresh-Air Adjustment with Ambient Air

5.2.1.1 Turn ON the CMS-4 by pressing and holding the POWER/MODE button until the alarm beeps. Allow the monitor to finish its warm-up sequence.

5.2.1.2 Press and hold the AIR button. While pressing the AIR button, the LCD displays *HOLD*, a prompt to keep pressing the AIR button.

5.2.1.3 When the fresh-air baseline has been set, the LCD displays “Adj,” and a prompt to *RELEASE* the AIR button. The monitor beeps once and the screen displays 0 ppm, as shown in Figure 20.

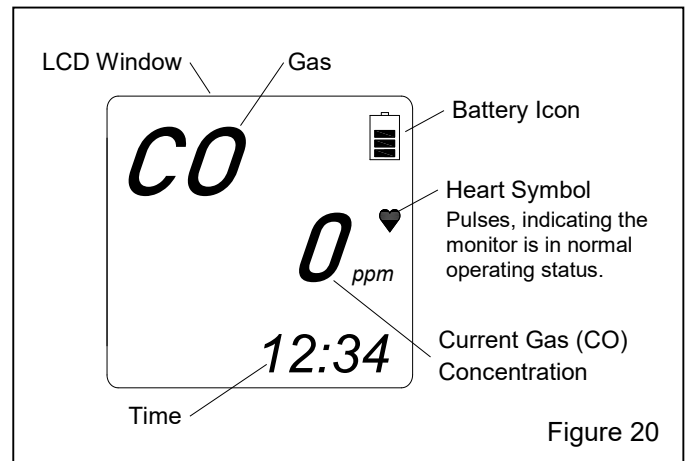

Figure 20

5.2.1.4 The monitor is now in Measuring Mode (normal operation). After an initial calibration per Section 5.7, the CMS-4 is ready for monitoring.

5.2.2 Fresh-Air Adjustment with Impurity-Free (0 ppm CO) Test Gas

The following is required to set the fresh-air baseline with impurity-free test gas:

- Impurity-free test gas, Stock No. 11132
- Calibration connector with 0.5 LPM fixed-flow slide valve, tubing, and calibration cup.

5.2.2.1 Make sure the monitor is off.

5.2.2.2 Prepare the calibration-connector regulator valve and impurity-free test gas, per Section 5.3.

5.2.2.3 Turn ON the CMS-4 by pressing and holding the POWER/MODE button until the alarm beeps. Allow the monitor to finish its warm-up sequence.

5.2.2.4 Open the connector slide valve by sliding it to the OPEN position, away from the cylinder.

5.2.2.5 Press and hold the AIR button. While pressing the AIR button, the LCD displays *HOLD*, a prompt to keep pressing the AIR button.

5.2.2.6 When the fresh-air baseline has been set, the LCD displays “Adj,” and a prompt to *RELEASE* the AIR button. The monitor beeps once and the screen displays 0 ppm, as shown in Figure 20.

5.2.2.7 The monitor is now in Measuring Mode (normal operation). After an initial calibration per Section 5.7, the CMS-4 is ready for monitoring.

5.2.2.8 Close the connector slide valve by sliding it to the CLOSE position, toward the test gas cylinder.

5.2.2.9 Remove the calibration cup by gently prying the retaining clips off the monitor while lifting up on the cup. Refer to Section 5.5 for additional information on removing the calibration cup.

5.2.2.10 Unscrew the calibration connector with slide valve from the test gas cylinder. The test gas cylinder has a positive seal, whereas the calibration-connector valve does not. If the connector is not removed from the test gas cylinder, over time the cylinder will empty.

5.2.2.11 Refer to Section 5.8 for information on storing the calibration kit and test gas.

5.3 Prepare Calibration-Connector Regulator Valve for Calibration – Figure 21

5.3.1 The following materials are required to prepare the calibration connector and test gas.

- Calibration Test-Gas Cylinder (25 ppm CO)
 - Or
- Impurity-Free Air Cylinder (used when setting fresh-air baseline, per Section 5.2.2)
- Calibration Connector with 0.5 LPM Fixed-Flow Slide Valve
- Calibration Tubing
- Calibration Cup

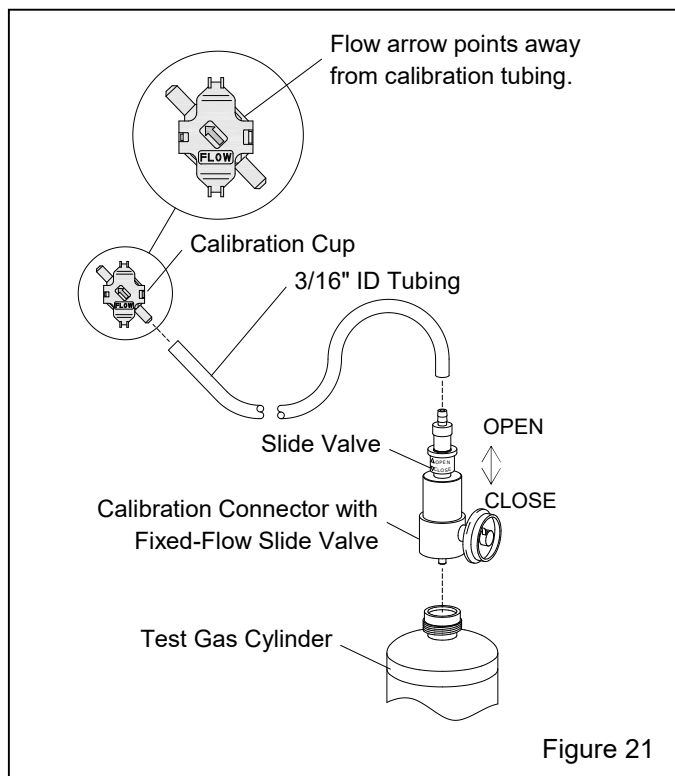

5.3.2 Slide one end of the 3/16" clear tubing onto the barbed end of the calibration connector with slide valve.

5.3.3 Slide the other end of the 3/16" tubing onto the inlet barb of the calibration cup. **NOTE: The calibration cup (shaded in Figure 21) has directional flow. The flow-direction arrow shows the direction of air flow.** The tube connects to the barb on the backend of the flow arrow, as shown. The outlet barb (on the front end of the flow arrow) remains open.

5.3.4 Make sure the slide valve is CLOSED by sliding it toward the test gas cylinder, as shown in Figure 21.

5.3.5 Screw the calibration connector with slide valve onto the test gas cylinder. **NOTE: Test gas can be 25 ppm CO used to calibrate the monitor, or it can be impurity-free air used to set fresh-air baseline when using impurity-free air, per Section 5.2.2.**

5.4 Connect Calibration Cup to Monitor – Figure 22

5.4.1 Prepare the calibration connector with slide valve for calibration, per Section 5.3. Make sure the connector's slide valve is closed.

5.4.2 Before attaching the calibration cup onto the monitor, make sure it is correctly positioned, as shown in Figure 22. The cup's flow arrow must point up and to the left, as shown.

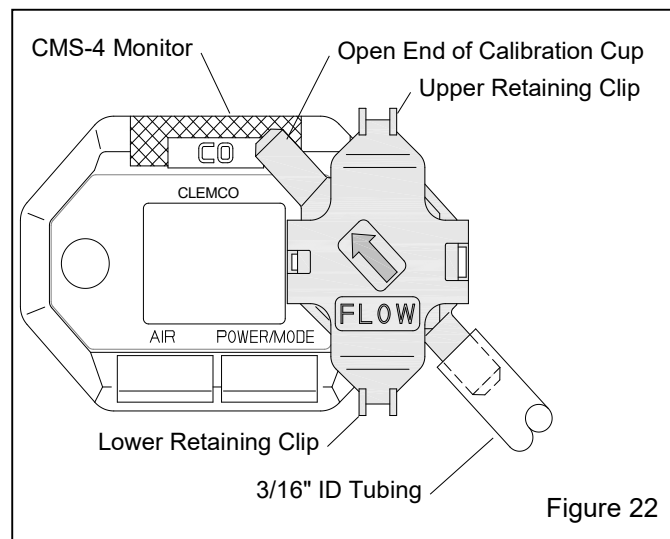

5.4.3 To attach the cup, refer to Figure 23 and hook the calibration cup's lower retaining clip under the lower slot, as shown in Figure 23.

5.4.4 Gently press the other end of the cup onto the monitor until it snaps into place, as shown in Figure 24. Do not force it; if it does not easily snap into place, make sure the cup's flow arrow points up and to the left of the monitor, as shown in Figure 22.

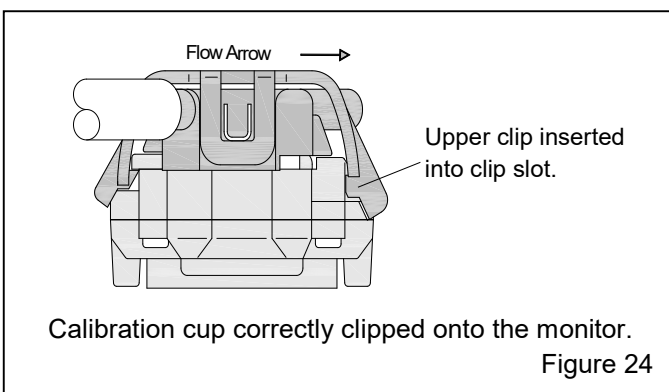
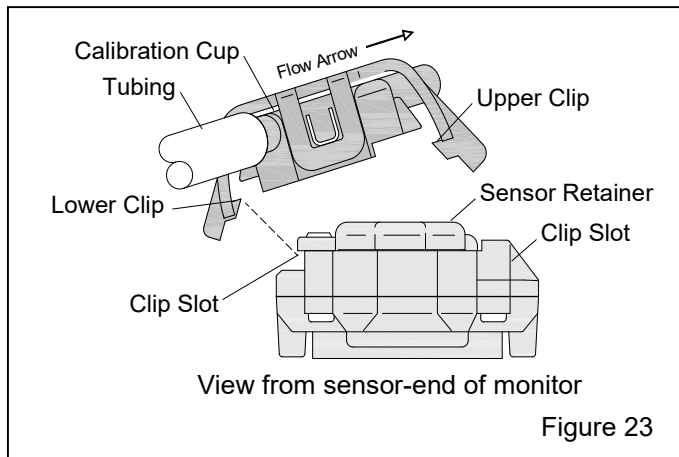

5.4.5 Close the connector slide valve by sliding it to the CLOSE position, toward the test gas cylinder.

5.4.6 Remove the calibration cup by gently prying the retaining clips off the monitor while lifting up on the cup. Refer to Section 5.5 for additional information on removing the calibration cup.

5.5 Remove Calibration Cup from Monitor

5.5.1 Make sure the connector's slide valve is closed by sliding it to the CLOSE position, toward the test gas cylinder.

5.5.2 To remove the calibration cup from the monitor, gently pry the upper retaining clip off the monitor while lifting up on the cup, as shown in Figure 25.

5.5.3 Unscrew the calibration connector from the test gas cylinder. The test gas cylinder has a positive seal, whereas the calibration-connector valve does not. If the connector is not removed from the test gas cylinder, over time the cylinder will empty.

5.5.4 Refer to Section 5.8 for information on storing the calibration kit and test gas.

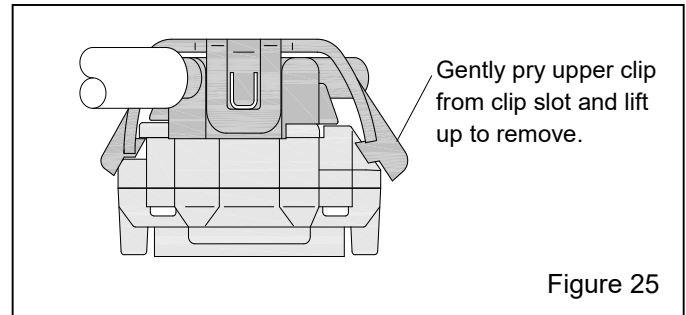

5.6 Performing a Bump Test

A bump test is a fast way to determine if the monitor is calibrated within a few ppm of the test gas. If the bump test fails, a calibration is immediately and automatically started.

A bump test should be done in a fresh-air environment, as used to set the fresh-air baseline.

The following are required to bump test the CMS-4:

- Test gas with 25 ppm concentration of CO, Stock No. 25573.
- Calibration connector with 0.5 LPM fixed-flow slide valve, tubing, and calibration cup. Stock No. 29767, assembled, as noted in Section 5.3.

5.6.1 Make sure the fresh-air baseline was set per Section 5.2.

5.6.2 Prepare the calibration-connector regulator valve and 25 ppm CO test gas, per Section 5.3. Make sure the slide valve is closed.

5.6.3 With the monitor OFF, press and hold AIR and POWER MODE. Release both buttons when the monitor beeps. *BUMP* is displayed on the LCD. The monitor is now in User Mode.

5.6.4 Press and release POWER/MODE once. The calibration value (25 ppm) displays on the right side of the screen.

5.6.5 Connect the calibration cup to the front of the monitor over the sensor retainer. (The sensor retainer is located to the right of the LCD screen.) The calibration cup's arrow must point up and to the left, as shown in Figures 21 and 22. Gently press the cup onto the monitor until it snaps into place. Refer to Section 5.4 for additional information on connecting the calibration cup to the monitor.

5.6.6 Open the connector slide valve by sliding it to the OPEN position (away from the cylinder). Refer to Figure 21.

5.6.7 Press and release POWER/MODE once. The gas reading will flash and the monitor will count down from 30 seconds in the lower-right corner. The bottom of the screen will alternate between *APLY* and *BUMP*.

5.6.8 Once the countdown reaches zero, the bump test is performed.

5.6.9 If the bump test passes, the LCD will display P (passed) and BMP/CAL, as shown in Figure 26. Proceed to Section 5.6.11.

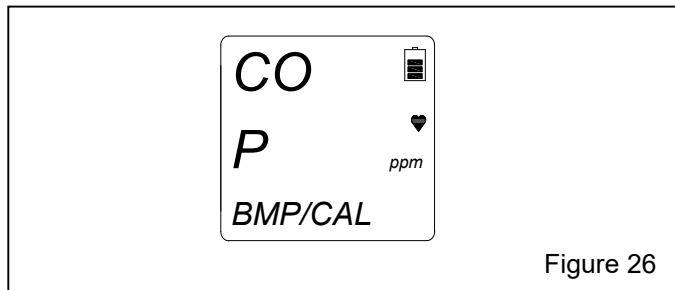

Figure 26

5.6.10 If the bump test failed, a calibration is immediately and automatically started. Continue to apply the calibration gas. AUTO CAL will appear at the bottom of the screen, and a countdown will appear at the top.

5.6.11 Close the connector slide valve by sliding it to the CLOSE position, toward the test gas cylinder

5.6.12 Remove the calibration cup by gently prying the retaining clips off the monitor while lifting up on the cup. Refer to Section 5.5 for additional information on removing the calibration cup.

5.6.13 Press and release POWER/MODE; the instrument displays *END* and then changes to *BUMP*. The monitor is now in User Mode.

5.6.14 If any channel failed the calibration, the LEDs will flash and the alarm will sound a double-pulsing tone until POWER/MODE is pressed and released, which returns the *BUMP* menu (User Mode). Refer to Section 7.0: *Troubleshooting*.

5.6.15 Press and release AIR 14 times (14 beeps) to scroll to *START*.

5.6.16 Press and release POWER/MODE to start the warm-up sequence and return to Measuring Mode.

5.6.17 The bump test is complete.

5.6.18 Refer to Section 5.8 for additional information on removing and storing the connector and test gas.

5.7 Calibrating the CMS-4

Calibrate the monitor in a fresh-air environment, as when used to set the fresh-air baseline.

The following are required to calibrate the CMS-4:

- Test gas with 25 ppm concentration of CO, Stock No. 25573.
- Calibration connector with 0.5 LPM fixed-flow slide valve, tubing, and calibration cup Stock No. 29767, assembled, as noted in Section 5.3.

5.7.1 Make sure the fresh-air baseline was set per Section 5.2.

5.7.2 Prepare the calibration-connector regulator valve and 25 ppm CO test gas, per Section 5.3. Make sure the slide valve is closed.

5.7.3 With the monitor OFF, press and hold AIR and POWER MODE. Release both buttons when the monitor beeps. *BUMP* is displayed on the LCD. The monitor is now in User Mode.

5.7.4 Press and release AIR once (1 beep) to scroll to GAS CAL. Press POWER/MODE.

5.7.5 Press and release AIR once (1 beep) to scroll to A-CAL. (NOTE: If *E-CAL* displays instead of *A-CAL*, the monitor is in the incorrect mode. Refer to Section 4.4 Maintenance Mode to return to factory default settings.

5.7.6 Press POWER/MODE once (1 beep). The calibration value (25) displays on the right side of the screen.

5.7.7 Press POWER MODE again. The gas reading will start to flash.

5.7.8 Connect the calibration cup to the front of the monitor over the sensor retainer. (The sensor retainer is located to the right of the LCD screen.) The calibration cup's flow arrow must point up and to the left, as shown in Figures 21 and 22. Gently press the cup onto the monitor until it snaps into place. Refer to Section 5.4 for additional information on connecting the calibration cup to the monitor.

5.7.9 Open the connector slide valve by sliding it to the OPEN position (away from the cylinder). Refer to Figure 21.

5.7.10 Allow gas to flow for one minute.

5.7.11 Press and release POWER MODE once. The monitor begins calibration.

5.7.12 If the calibration was successful, the LCD will briefly display *PASS* and the monitor returns to the A-CAL menu.

5.7.13 If the calibration failed, the LCD will display *FAIL*, the LEDs will flash, and the alarm will sound. Press and release *POWER/MODE* to clear the failure. The monitor returns to the A-CAL menu. Refer to Section 7.0: *Troubleshooting*.

5.7.14 Close the connector slide valve by sliding it to the *CLOSE* position, toward the test gas cylinder.

5.7.15 Remove the calibration cup by gently prying the retaining clips off the monitor while lifting up on the cup. Refer to Section 5.5 for additional information on removing the calibration cup.

5.7.16 Press *AIR* once (1 beep) to scroll to *ESCAPE*.

5.7.17 Press and release *POWER MODE* to return to User Mode. Check to see if the monitor returns to Measuring Mode if no buttons are pushed after 20 seconds.

5.7.18 Press and release *AIR* 13 times (13 beeps) to scroll to *START*.

5.7.19 Press *POWER/MODE* once to start the warm-up sequence and return to Measuring Mode.

5.7.20 The calibration is complete.

5.7.21 Refer to Section 5.8 for information on storing the calibration kit and test gas.

5.8 Storing the Calibration Kit and Test Gas

5.8.1 Remove the calibration cup from the monitor, per Section 5.5.

5.8.2 Unscrew the calibration connector with slide valve from the test gas cylinder. The test gas cylinder has a positive seal, whereas the calibration-connector valve does not. If the connector is not removed from the test gas cylinder, over time the cylinder will empty.

5.8.3 Place the calibration kit and test gas in a plastic bag or other sealed container, and store it in a clean, dry place.

6.0 MAINTENANCE

⚠ WARNING

Regularly scheduled calibration and maintenance is essential for proper operation and accurate readings of the monitor. Maintenance should be performed by personnel properly trained for this work. Improper service could result in malfunction and loss of life.

NOTE: There are no serviceable parts within the CMS-4 case. Do not remove the four screws holding the upper and lower case together or try to separate the case.

6.1 Replacing the Lithium Battery – Figures 27 and 28

The battery icon has three bars visible when the battery has full power. As the battery charge decreases, the bars disappear. Obtain a replacement CR2450 3V Lithium coin battery when there is one bar remaining on the battery icon. Replace the battery when the lowest battery level indication bar disappears and the battery icon begins to flash, indicating that the monitor is in low battery warning.

6.1.1 Make sure the monitor is turned OFF.

6.1.2 From the back of the monitor, pry the mounting clip off the spring pin and swing it away from the battery cover, as shown in Figure 27.

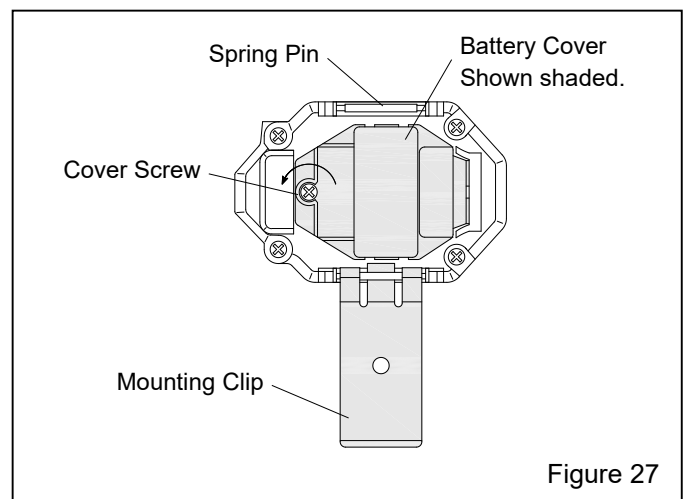

Figure 27

6.1.3 Use a small Phillips screwdriver to unscrew the battery cover's screw and swing the cover away from the monitor to remove it.

6.1.4 Carefully remove the old battery.

6.1.5 Carefully install the new battery, noting the polarity indications on the underside of the battery cover and in the battery compartment. The negative (-) side of the battery goes into the monitor, as shown in Figure 28.

6.1.6 Reinstall the battery cover and screw.

NOTE: If the instrument has been without a battery for more than 5 minutes, the date and time are reset and need to be set again. When the new battery is installed, the instrument will turn on automatically and will display the Date/Time Screen. Reset the date and time, as described in *Section 2.3: Setting the Date and Time*. Once the date and time have been set, the instrument will begin its warm-up sequence. If the date and time are not set within 30 seconds, the instrument will automatically begin its warm-up sequence.

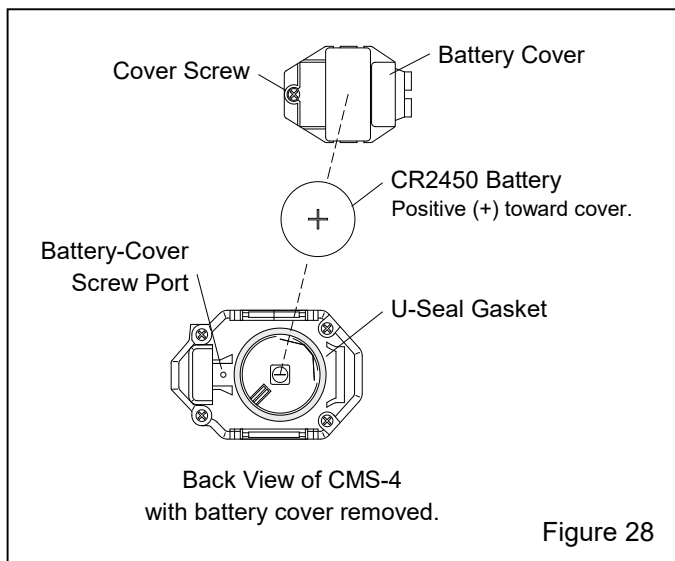

Figure 28

6.2 Replacing the Sensor – Figures 29 and 30

NOTE: Replace the sensor in a clean, nonhazardous environment. Make sure a new hydrophobic filter and charcoal filter are available before changing the sensor.

- 6.2.1** Make sure the monitor is turned OFF.
- 6.2.2** Use a small Phillips screwdriver to unscrew the sensor-retainer's screw.
- 6.2.3** Remove the sensor retainer.
- 6.2.4** Remove the sensor gasket and filters. The filters may fall out. The sensor will be exposed.
- 6.2.5** Remove the old sensor by pulling it straight up from the sensor socket. **NOTE: The bottom of the sensor is slotted and can only be inserted in the**

socket one way, as shown in Figure 29. Before removing the sensor, note the orientation of the old sensor alignment points, as shown in Figure 30. The new sensor will insert with the same orientation.

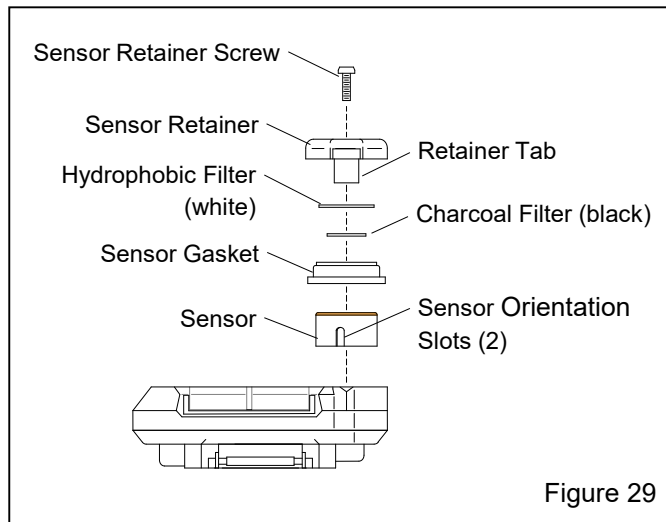

Figure 29

NOTICE

Do not force the sensor into the socket; when correctly oriented, the sensor easily fits into the socket. Forcing it could damage the sensor or the socket.

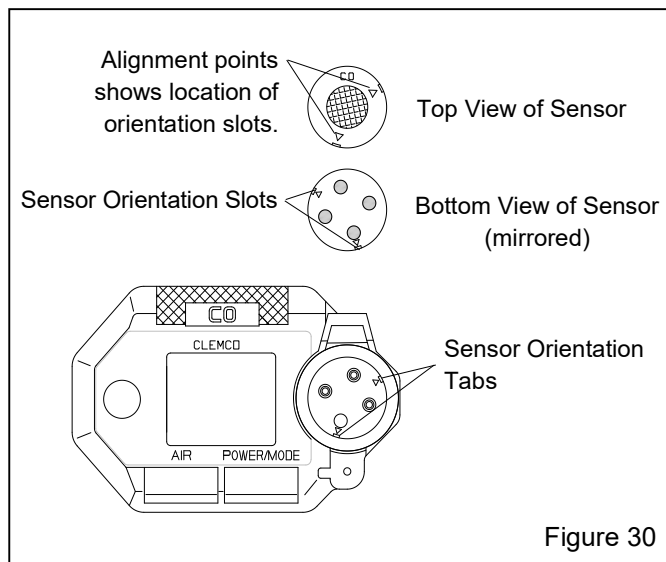

Figure 30

6.2.6 Carefully insert the replacement sensor. Make sure the sensor face with the colored ring is facing up, and that the sensor's orientation slots are aligned correctly with the tabs within the socket, as shown in Figure 30. Do not force the sensor into its socket; if the sensor is correctly aligned, it easily sets into the socket.

6.2.7 Place the wide side of the sensor gasket over the sensor and push it into the recess, as shown in Figure 31.

6.2.8 Install a new charcoal filter. It should be seated and recessed in the center of the sensor gasket.

6.2.9 Install a new white hydrophobic filter. It should be seated and recessed in the sensor gasket and should not overlap the edge of the sensor gasket.

6.2.10 Clip the sensor retainer over the filters and sensor gasket and tighten its screw.

6.2.11 Calibrate the new sensor, as described in *Section 5.7: Calibrating the CMS-4*.

6.3 Replacing the Charcoal Filter – Figure 31

NOTE: Replace the charcoal filter in a clean, nonhazardous environment.

6.3.1 Make sure the monitor is turned OFF.

6.3.2 Use a small Phillips screwdriver to unscrew the sensor-retainer screw.

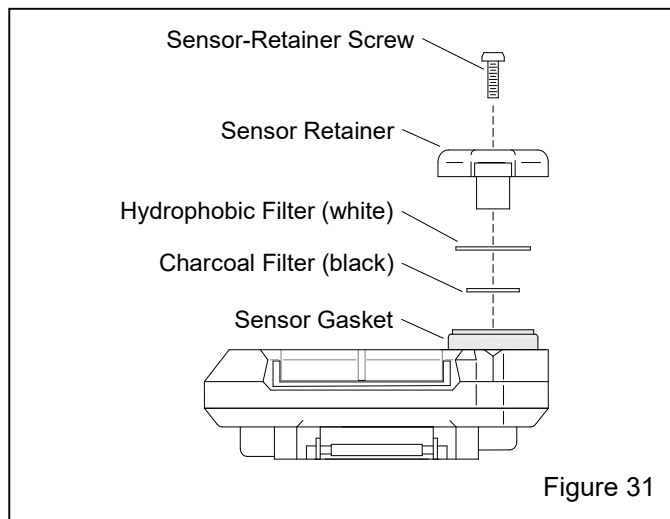

6.3.3 Remove the sensor retainer.

6.3.4 The white hydrophobic filter and the sensor gasket should stay on the sensor.

6.3.5 Remove the white hydrophobic filter.

6.3.6 Remove the old black charcoal filter from the center of the sensor gasket.

6.3.7 Install the new charcoal filter. It should be seated and recessed in the center of the sensor gasket.

6.3.8 Reinstall the white hydrophobic filter. It should be seated and recessed in the sensor gasket and should not overlap the edge of the sensor gasket.

6.3.9 Clip the sensor retainer over the filters and sensor gasket, and tighten its screw.

6.4 Replacing the Hydrophobic Filter – Figure 32

NOTE: Replace the hydrophobic filter in a clean, nonhazardous environment. Replace the charcoal filter when replacing the hydrophobic filter.

6.4.1 Make sure the monitor is turned OFF.

6.4.2 Use a small Phillips screwdriver to unscrew the sensor-retainer screw.

6.4.3 Remove the sensor retainer.

6.4.4 The white hydrophobic filter and the sensor gasket should stay on the sensor.

6.4.5 Remove the old hydrophobic filter.

6.4.6 Remove the old black charcoal filter from the center of the sensor gasket. We recommend changing the charcoal filter when changing the hydrophobic filter.

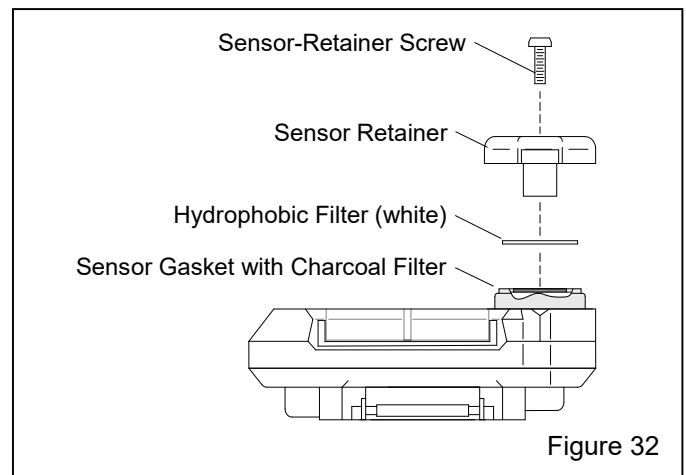

6.4.7 Install the new charcoal filter. It should be seated and recessed in the center of the sensor gasket.

6.4.8 Install the new hydrophobic filter. It should be seated and recessed in the sensor gasket and should not overlap the edge of the sensor gasket.

6.4.9 Clip the sensor retainer over the filters and sensor gasket, and tighten its screw.

7.0 TROUBLESHOOTING

The troubleshooting table describes error messages, symptoms, probable causes, and recommended action for problems encountered with the CMS-4.

NOTE: If the monitor does not display menu items that are noted within these instructions, repeat the process. If after repeating the process the monitor still does not display the correct menu item, return the monitor to factory settings, per Section 4.4.

Symptoms	Probable Causes	Recommended Action
The LCD is blank.	The monitor may have been turned off.	1. To turn on the monitor, press and briefly hold POWER/MODE.
	The battery was inserted backwards.	1. Reinstall the battery in the correct orientation.
	Battery may need to be replaced.	1. Check battery ICON for remaining battery life.
	The battery cover may not be completely closed.	1. Be sure the battery cover is completely closed and that the screw is tight. 2. If the difficulties continue, contact the Clemco distributor the monitor was purchased through for further instruction.
The LCD shows an abnormally high reading, but other gas detection instruments do not.	Charcoal filter may need to be replaced.	1. Replace the charcoal filter.
	The CMS-4 may need to be recalibrated.	1. Recalibrate the monitor. 2. If the difficulties continue, replace the sensor and calibrate.
	The sensor may need replacement.	1. Recalibrate the monitor. 2. If the difficulties continue, replace the sensor and calibrate.
Calibration fails.	The calibration gas values may not match the cylinder gas concentration.	1. Make sure test gas and gas value are 25 ppm. Refer to Sections 5.6 and 5.7. 2. Make sure the CMS-4 has been properly set up for calibration. 3. If the fail condition continues, replace the sensor. 4. If difficulties continue, contact the Clemco distributor the monitor was purchased through for further instruction.
	The sample gas is not reaching the sensor because of a bad connection.	1. Check all calibration tubing for leaks or for any bad connections.
	The calibration cylinder may be out of gas or is outdated.	1. Verify that the calibration cylinder contains an adequate supply of fresh test sample.
	The sensor may need replacement.	1. If the fail condition continues, replace the sensor. 2. If difficulties continue, contact the Clemco distributor the monitor was purchased through for further instruction.
Heart symbol at the top of the screen becomes steadily on or disappears.	A microprocessor error has occurred.	1. Contact the Clemco distributor the monitor was purchased through for further instruction.
Monitor does not display menu items as noted within the instructions.	Factory settings accidentally changed.	1. Return to factory default settings per Section 4.4.

8.0 REPLACEMENT PARTS

8.1 System Replacement Parts, Figure 33

Item	Description	Stock No.
(-)	CMS-4 CO Monitor Package	
	Includes items shown with asterisk (*)	29765
1. *	CMS-4 CO monitor, instrument only	29766
2. *	Calibration kit	29767
3.	Test gas,	
*	25 ppm CO	25573
	Impurity-free	11132
4.	Calibration connector with	
	0.5 LPM fixed-flow slide valve	25572
5.	Calibration cup	29764
6.	Tubing, 3/16 ID, 2-feet required	13074
7. *	Velcro® tape, loop side	
	Included with kit 29870, shown in Figure 34	
8. *	Velcro® tape, hook side	
	Included with kit 29870, shown in Figure 34	
9. *	Mounting strip assembly	
	used with Apollo 60 and 600 only	
	Included with kit 29870, shown in Figure 34.	

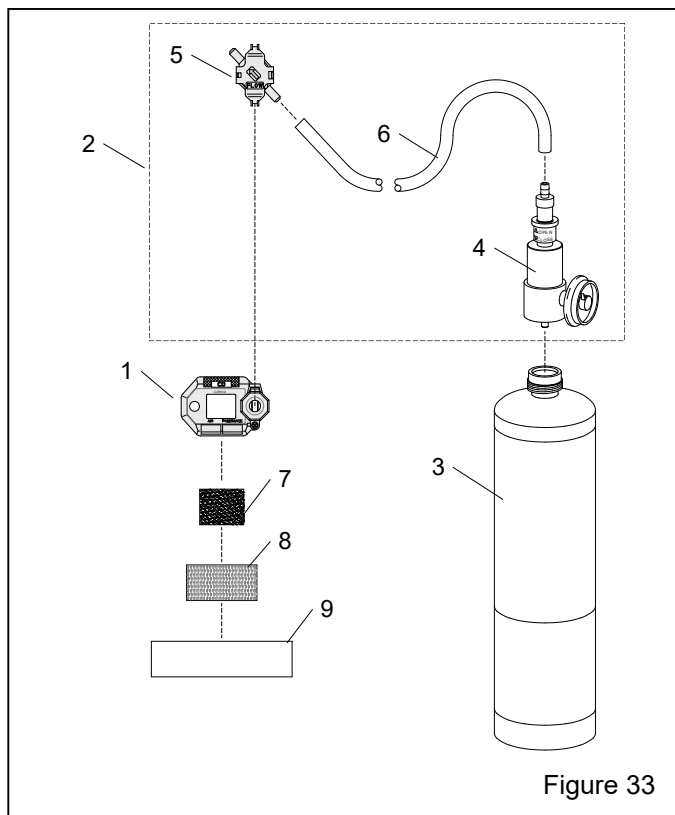

Figure 33

8.2 Monitor Replacement Parts – Figure 34

NOTE: There are no serviceable parts within the CMS-4 case. Do not remove the four screws holding the upper and lower case together or try to separate the case.

Item	Description	Stock No.
1. *	Sensor, CMS-4	29768
2.	Retainer, sensor.....	29769
3.	Retainer, battery	29770
4.	Gasket, sensor	29771
5.	Gasket, battery retainer	29772
6. *	Filter, hydrophobic, each	29868
7. *	Filter, charcoal, pack of 5	25564
8.	Mounting clip	29869
9.	Battery, 3V Lithium coin	24619
	or purchase model CR2450 locally	
10.	Service kit, includes items 10a thru 10e	29870
10a	Screw set (2), sensor and battery retainers	
10b	Velcro® tape, loop side, 1" x 1-1/4"	
10c	Velcro® tape, hook side, 1" x 2" (qty. of 2)	
10d	Mounting strip, transparent (qty. of 2)	
10e	Spring pin (qty. of 2)	

* Make sure a new hydrophobic filter (Item 6) and charcoal filter (Item 7) are available so they can be replaced when changing the sensor (Item 1).

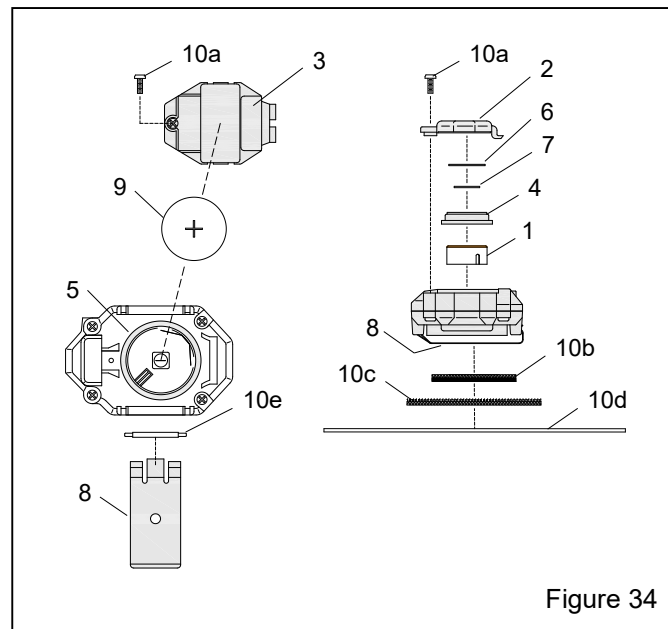

Figure 34