

**CLEM-COOL  
AIR CONDITIONER  
O. M. 23837**

MC FILE NUMBER: 2326-0407  
DATE OF ISSUE: 05-07-07  
REVISION: A, 03-08

 **WARNING**

**Do not proceed with these instructions until you have READ the orange cover of this MANUAL and YOU UNDERSTAND its contents. \***

**These WARNINGS are included for the health and safety of the operator and those in the immediate vicinity.**

**\*If you are using a Clemco Distributor Maintenance and Part Guide, refer to the orange warnings insert preceding the Index before continuing with the enclosed instructions.**

**Electronic files include a Preface containing the same important information as the orange cover.**

© 2008 CLEMCO INDUSTRIES CORP.  
One Cable Car Dr.  
Washington, MO 63090  
Phone (636) 239-4300  
Fax (800) 726-7559  
Email: [info@clemcoindustries.com](mailto:info@clemcoindustries.com)  
[www.clemcoindustries.com](http://www.clemcoindustries.com)



**⚠ WARNING**

- Read and follow ALL instructions before using this equipment.
- Failure to comply with ALL instructions can result in serious injury or death.
- In the event that the user, or any assistants of the user of this equipment cannot read or cannot completely understand the warnings and information contained in these instructions, the employer of the user and his assistants must thoroughly educate and train them on the proper operation and safety procedures of this equipment.

**NOTICE TO PURCHASERS AND USERS OF OUR PRODUCTS AND THIS INFORMATIONAL MATERIAL**

The products described in this material, and the information relating to those products, is intended for knowledgeable, experienced users of abrasive blasting equipment.

No representation is intended or made as to the suitability of the products described herein for any particular purpose or application. No representations are intended or made as to the efficiency, production rate, or the useful life of the products described herein. Any estimate regarding production rates or production finishes are the responsibility of the user and must be derived solely from the user's experience and expertise, and must not be based on information in this material.

The products described in this material may be combined by the user in a variety of ways for purposes determined solely by the user. No representations are intended or made as to the suitability or engineering balance of the combination of products determined by the user in his selection, nor as to the compliance with regulations or standard practice of such combinations of components or products.

Abrasive Blast Equipment is only a component of the range of equipment used in an abrasive blasting job. Other products may include an air compressor, abrasive, scaffolding, hydraulic work platforms or booms, paint spray equipment, dehumidification equipment, air filters and receivers, lights, ventilation equipment, parts handling equipment, specialized respirators, or equipment that while offered by Clemco may have been supplied by others. Each manufacturer and supplier of the other products used in the abrasive blasting job must be contacted for information, training, instruction and warnings with regard to the proper and safe use of their equipment in the particular application for which the equipment is being used. The information provided by Clemco is intended to provide instruction only on Clemco products. All operators must be trained in the proper, safe, use of this equipment. It is the responsibility of the users to familiarize themselves with, and comply with, all appropriate laws, regulations, and safe practices that apply to the use of these products. Consult with your employer about training programs and materials that are available.

Our company is proud to provide a variety of products to the abrasive blasting industry, and we have confidence that the professionals in our industry will utilize their knowledge and expertise in the safe efficient use of these products.

**GENERAL INSTRUCTIONS**

Described herein are some, BUT NOT ALL, of the major requirements for safe and productive use of blast machines, remote control systems, operator respirator assemblies, and related accessories. Completely read ALL instruction manuals prior to using equipment.

The user's work environment may include certain HAZARDS related to the abrasive blasting operation. Proper protection for the blaster, as well as anyone else that may be EXPOSED to the hazards generated by the blasting process, is the responsibility of the user and/or the employer. Operators MUST consult with their employer about what hazards may be present in the work environment including, but not limited to, exposure to dust that may contain TOXIC MATERIALS due to the presence of silica, cyanide, arsenic or other toxins in the abrasive, or materials present in the surface to be blasted such as lead or heavy metals in coatings. The environment may also include fumes that may be present from adjacent coatings application, contaminated water, engine exhaust, chemicals, and asbestos. The work area may include PHYSICAL HAZARDS such as an uneven work surface, poor visibility, excess noise, and electrical hazards. The operator MUST consult with his employer on the identification of potential hazards, and the appropriate measures that MUST be taken to protect the blaster and others that might be exposed to these hazards.

ALL machines, components and accessories MUST be installed, tested, operated and maintained only by trained, knowledgeable, experienced users.

DO NOT modify or substitute any Clemco parts with other types or brands of equipment. Unauthorized modification and parts substitution on supplied air respirators is a violation of OSHA regulations and voids the NIOSH approval.

**OPERATIONAL INSTRUCTIONS**

**OPERATOR SAFETY EQUIPMENT**

**⚠ WARNING**

- Blast operators and others working in the vicinity of abrasive blasting must always wear properly-maintained, NIOSH-approved, respiratory protection appropriate for the job site hazards.
- DO NOT USE abrasives containing more than one percent crystalline (free) silica. Ref. NIOSH Alert #92-102
- Inhalation of toxic dust (crystalline silica, asbestos, lead paint and other toxins) can lead to serious or fatal disease (silicosis, asbestosis, lead or other poisoning).

- ALWAYS wear NIOSH-approved supplied-air respirators as required by OSHA, in the presence of any dust including, but not limited to, handling or loading abrasive; blasting or working in the vicinity of blast jobs; and cleanup of expended abrasive. Prior to removing respirator, an air monitoring

instrument should be used to determine when surrounding atmosphere is clear of dust and safe to breathe.

- NIOSH-approved, supplied-air respirators are to be worn ONLY in atmospheres:
  - NOT IMMEDIATELY dangerous to life or health and,
  - from which a user can escape WITHOUT using the respirator.
- Clemco supplied-air respirators **DO NOT REMOVE OR PROTECT AGAINST CARBON MONOXIDE (CO) OR ANY OTHER TOXIC GAS**. Carbon monoxide and toxic gas removal and/or monitoring device must be used in conjunction with respirator to insure safe breathing air.
- Air supplied to respirator **MUST BE AT LEAST GRADE D QUALITY** as described in Compressed Gas Association Commodity Specification G-7.1, and as specified by OSHA Regulation 1910.139 (d).
- ALWAYS locate compressors to prevent contaminated air (such as CO from engine exhaust) from entering the air intake system. A suitable in-line air purifying sorbent bed and filter or CO Monitor should be installed to assure breathing air quality.
- ALWAYS use a NIOSH-approved breathing air hose to connect an appropriate air filter to the respirator. Use of a non-approved air hose can subject the operator to illness caused by the release of chemical agents used in the manufacture of non-approved breathing air hose.
- ALWAYS check to make sure air filter and respirator system hoses are NOT CONNECTED to in-plant lines that contain nitrogen, acetylene or any other non-breathable gas. NEVER use oxygen with air line respirators. NEVER modify air line connections to accommodate air filter/respirator breathing hose WITHOUT FIRST testing content of the air line. **FAILURE TO TEST THE AIR LINE MAY RESULT IN DEATH TO THE RESPIRATOR USER.**
- Respirator lenses are designed to protect against rebounding abrasive. They do not protect against flying objects, glare, liquids, radiation or high speed heavy materials. Substitute lenses from sources other than the original respirator manufacturer will void NIOSH-approval of this respirator.

**BLAST MACHINES AND REMOTE CONTROLS**

 <b>WARNING</b>
<ul style="list-style-type: none"> <li>• <b>ALWAYS</b> equip abrasive blast machines with remote controls.</li> <li>• <b>Abrasive blast machine operators must wear NIOSH-approved supplied-air respirators (ref: OSHA regulations 1910.94, 1910.132, 1910.139 and 1910.244).</b></li> </ul>

- NEVER modify OR substitute remote control parts. Parts from different manufacturers are NOT compatible with Clemco

equipment. If controls are altered, involuntary activation, which may cause serious injury, can occur.

- Inspect the air control orifice DAILY for cleanliness. NEVER use welding hose in place of twinline control hose. The internal diameter and rubber composition are UNSAFE for remote control use.
- UNLESS OTHERWISE SPECIFIED, maximum working pressure of blast machines and related components MUST NOT exceed National Board approved 125 psig (8.5 BAR).
- NEVER weld on blast machine. Welding may affect dimensional integrity of steel wall and WILL VOID National Board approval.
- Point nozzle ONLY at structure being blasted. High velocity abrasive particles WILL inflict serious injury. Keep unprotected workers OUT of blast area.
- NEVER attempt to manually move blast machine when it contains abrasive. EMPTY machines, up to 6 cu. ft.(270kg) capacity, are designed to be moved:
  - on flat, smooth surfaces by AT LEAST two people;
  - with the Clemco "Mule"; or
  - with other specially designed machine moving devices.
- Larger empty blast machines or ANY blast machine containing abrasive MUST be transported by mechanical lifting equipment.

**AIR HOSE, BLAST HOSE, COUPLINGS, AND NOZZLE HOLDERS**

- Air hose, air hose fittings and connectors at compressors and blast machines MUST be FOUR times the size of the nozzle orifice. Air hose lengths MUST be kept as short as possible AND in a straight line. Inspect DAILY and repair leakage IMMEDIATELY.
- Blast hose inside diameter MUST be THREE to FOUR times the size of the nozzle orifice. AVOID sharp bends that wear out hose rapidly. Use SHORTEST hose lengths possible to reduce pressure loss. Check blast hose DAILY for soft spots. Repair or replace IMMEDIATELY.
- ALWAYS cut loose hose ends square when installing hose couplings and nozzle holders to allow uniform fit of hose to coupling shoulder. NEVER install couplings or nozzle holders that DO NOT provide a TIGHT fit on hose. ALWAYS use manufacturers recommended coupling screws.
- Replace coupling gaskets FREQUENTLY to prevent leakage. Abrasive leakage can result in dangerous coupling failure. ALL gaskets MUST be checked SEVERAL times during a working day for wear, distortion and softness.
- Install safety pins at EVERY coupling connection to prevent accidental disengagement during hose movement.
- ALWAYS attach safety cables at ALL air hose AND blast hose coupling connections. Cables relieve tension on hose and control whipping action in the event of a coupling blow-out.

**MAINTENANCE**

- ALWAYS shut off compressor and depressurize blast machine BEFORE doing ANY maintenance.
- Always check and clean ALL filters, screens and alarm systems when doing any maintenance.
- ALWAYS cage springs BEFORE disassembling valves IF spring-loaded abrasive control valves are used.
- ALWAYS completely follow owner's manual instructions and maintain equipment at RECOMMENDED intervals.

**ADDITIONAL ASSISTANCE**

- Training and Educational Programs. Clemco Industries Corp. offers a booklet, Blast-Off 2, developed to educate personnel on abrasive blast equipment function and surface preparation techniques. Readers will learn safe and productive use of machines, components and various accessories, including selection of abrasive materials for specific surface profiles and degrees of cleanliness.
- The Society for Protective Coatings (SSPC) offers a video training series on protective coatings including one entitled "Surface Preparation." For loan or purchase information, contact SSPC at the address shown below.

**TECHNICAL DATA AND RESEARCH COMMITTEES**

- The following associations offer information, materials and videos relating to abrasive blasting and safe operating practices.

**The Society for Protective Coatings (SSPC)**  
 40 24th Street, Pittsburgh PA 15222-4643  
 Phone: (412) 281-2331 • FAX (412) 281-9992  
 Email: research@sspc.org • Website: www.sspc.org

**National Association of Corrosion Engineers (NACE)**  
 1440 South Creek Drive, Houston TX 77084  
 Phone: (281) 228-6200 • FAX (281) 228-6300  
 Email: msd@mail.nace.org • Website: www.nace.org

**American Society for Testing and Materials (ASTM)**  
 100 Barr Harbor Dr., West Conshohocken, PA 19428  
 Phone (610) 832-9500 • FAX (610) 832-9555  
 Email: service@astm.org • Website: www.astm.org

**NOTICE**

This equipment is not intended to be used in an area that might be considered a hazardous location as described in the National Electric Code NFPA 70 1996, article 500.

**WARRANTY**

The following is in lieu of all warranties express, implied or statutory and in no event shall seller or its agents, successors, nominees or assignees, or either, be liable for special or consequential damage arising out of a breach of warranty. This warranty does not apply to any damage or defect resulting from negligent or improper assembly or use of any item by the buyer or its agent or from alteration or attempted repair by any person other than an authorized agent of seller. All used, repaired, modified or altered items are purchased "as is" and with all faults. In no event shall seller be liable for consequential or incidental damages. The sole and exclusive remedy of buyer for breach of warranty by seller shall be repair or replacement of defective parts or, at seller's option, refund

of the purchase price, as set forth below:

1. Seller makes no warranty with respect to products used other than in accordance hereunder.
2. On products seller manufactures, seller warrants that all products are to be free from defects in workmanship and materials for a period of one year from date of shipment to buyer, but no warranty is made that the products are fit for a particular purpose.
3. On products which seller buys and resells pursuant to this order, seller warrants that the products shall carry the then standard warranties of the manufacturers thereof, a copy of which shall be made available to customer upon request.
4. The use of any sample or model in connection with this order is for illustrative purposes only and is not to be construed as a warranty that the product will conform to the sample or model.
5. Seller makes no warranty that the products are delivered free of the rightful claim of any third party by way of patent infringement or the like.
6. This warranty is conditioned upon seller's receipt within ten (10) days after a buyer's discovery of a defect, of a written notice stating in what specific material respects the product failed to meet this warranty. If such notice is timely given, seller will, at its option, either modify the product or part to correct the defect, replace the product or part with complying products or parts, or refund the amount paid for the defective product, any one of which will constitute the sole liability of seller and a full settlement of all claims. No allowance will be made for alterations or repairs made by other than those authorized by seller without the prior written consent of seller. Buyer shall afford seller prompt and reasonable opportunity to inspect the products for which any claim is made as above stated.

Except as expressly set forth above, all warranties, express, implied or statutory, including implied warranty of merchantability, are hereby disclaimed.

**DAILY SET-UP CHECK LIST**

 <b>WARNING</b>
<ul style="list-style-type: none"> <li>• <b>ALL</b> piping, fittings and hoses <b>MUST</b> be checked DAILY for tightness and leakage.</li> <li>• <b>ALL</b> equipment and components <b>MUST</b> be thoroughly checked for wear.</li> <li>• <b>ALL</b> worn or suspicious parts <b>MUST</b> be replaced.</li> <li>• <b>ALL</b> blast operators <b>MUST</b> be properly trained to operate equipment.</li> <li>• <b>ALL</b> blast operators <b>MUST</b> be properly outfitted with abrasive resistant clothing, safety shoes, leather gloves and ear protection.</li> <li>• <b>BEFORE</b> blasting <b>ALWAYS</b> use the following check list.</li> </ul>

**1. PROPERLY MAINTAINED AIR COMPRESSOR** sized to provide sufficient volume (cfm) for nozzle and other tools PLUS a 50% reserve to allow for nozzle wear. Use large compressor outlet and large air hose (4 times the nozzle orifice size). FOLLOW MANUFACTURERS MAINTENANCE INSTRUCTIONS.

**2. BREATHING AIR COMPRESSOR** (oil-less air pump) capable of providing Grade D Quality air located in a dust free, contaminant free area. If oil-lubricated air compressor is used to supply respirator, it should have high temperature monitor and CO monitor or both. If CO monitor is not used, air **MUST** be tested FREQUENTLY to ensure proper air quality.

**3. Clean, properly maintained NIOSH-APPROVED SUPPLIED-AIR RESPIRATOR.** ALL components should ALWAYS be present. NEVER operate without inner lens in place. Thoroughly inspect ALL components DAILY for cleanliness and wear. ANY substitution of parts voids NIOSH approval i.e. cape, lenses, breathing hose, breathing air supply hose, air control valve, cool air or climate control devices.

**4. OSHA required BREATHING AIR FILTER** for removal of moisture and particulate matter from breathing air supply. THIS DEVICE DOES NOT REMOVE OR DETECT CARBON MONOXIDE (CO). ALWAYS USE CO MONITOR ALARM.

**5. ASME CODED BLAST MACHINE** sized to hold 1/2 hour abrasive supply. ALWAYS ground machine to eliminate static electricity hazard. Examine pop up valve for alignment. Blast machine MUST be fitted with a screen to keep out foreign objects and a cover to prevent entry of moisture overnight.

**6. AIR LINE FILTER** installed AS CLOSE AS POSSIBLE to machine inlet. Sized to match inlet piping or larger air supply line. Clean filter DAILY. Drain OFTEN.

**7. REMOTE CONTROLS** MUST be in PERFECT operating condition. ONLY use APPROVED spare parts, including twin-line hose. DAILY: test system operation and check button bumper and spring action of lever and lever lock. DO NOT USE WELDING HOSE.

**8. BLAST HOSE** with ID 3 to 4 times the nozzle orifice. Lines MUST be run AS STRAIGHT AS POSSIBLE from machine to work area with NO sharp bends. Check DAILY for internal wear and external damage.

**9. HOSE COUPLINGS, NOZZLE HOLDERS** fitted SNUGLY to hose end and installed using PROPER coupling screws. Coupling lugs MUST be snapped FIRMLY into locking position. Gasket MUST form positive seal with safety pins inserted through pin holes. Check gaskets and replace if ANY sign of wear, softness or distortion. ALWAYS install safety cables at every connection to prevent disengagement. Check nozzle holder for worn threads. NEVER MIX DIFFERENT BRANDS OF COMPONENTS. Check each of these components DAILY.

**10. Inspect NOZZLE and GASKET DAILY** for wear. Replace nozzle when 1/16" larger than original size or if liner appears cracked. Check nozzle threads for wear.

**11. Use abrasive** that is properly sized and free of harmful substances; such as, free silica, cyanide, arsenic or lead. Check material data sheet for presence of toxic or harmful substances.

**12. Test surface** to be blasted for toxic substances. Take appropriate, and NIOSH required, protective measures for operator and bystanders which pertain to substances found on the surface to be blasted.

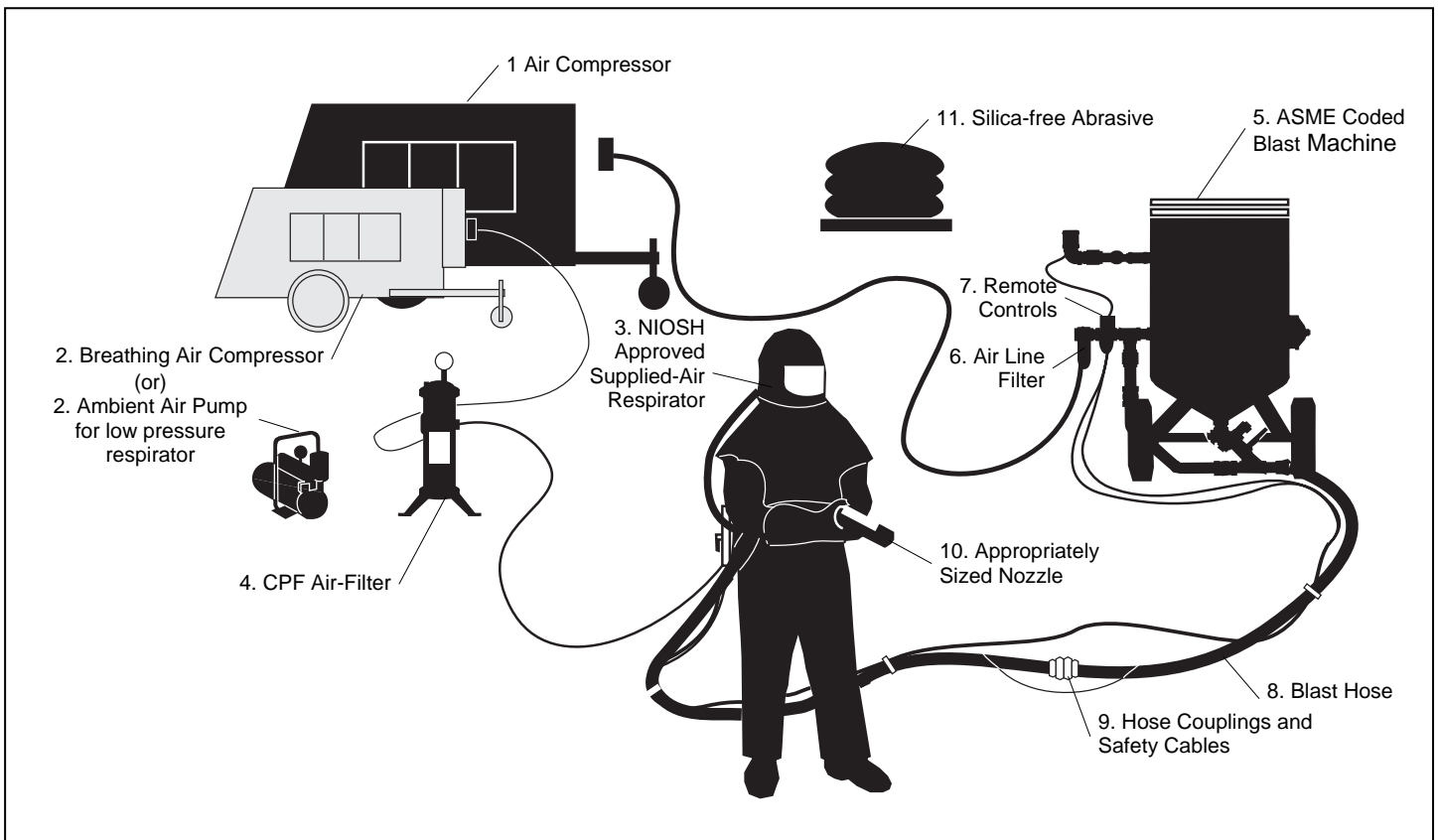

1.0 INTRODUCTION

1.1 Scope

1.1.1 This manual covers the preparation, operation, maintenance, troubleshooting, and replacement parts for Clemco's Clem-Cool Air Conditioner. The conditioner is used to cool compressed respirable air supplying an Apollo supplied-air respirator or Comfort Vest. Read this manual and the appropriate Apollo HP (high pressure) respirator manual and/or Comfort Vest manual before using the Clem-Cool air conditioner.

1.1.2 The National Institute for Occupational Safety and Health (NIOSH) approval and Occupational Safety & Health Administration (OSHA) regulations cited within this manual apply when the air conditioner is used to provide air to a supplied-air respirator. The regulations do not apply if the air conditioner is used with a Comfort Vest alone. When a vest is used with a respirator having a cape that extends over the vest, air from the vest could be inhaled by the user. For that reason, Grade D air or higher quality, as defined in Section 2.1 of this manual, must be provided to both the respirator and vest.

1.2 Safety Alerts

1.2.1 Clemco uses safety alert signal words, based on ANSI Z535.4-1998, to alert the user of a potentially hazardous situation that may be encountered while operating this equipment. ANSI's definitions of the signal words are as follows:



This is the safety alert symbol. It is used to alert the user of this equipment of potential personal injury hazards.

Obey all safety messages that follow this symbol to avoid possible injury or death.

**CAUTION**

Caution used without the safety alert symbol indicates a potentially hazardous situation which, if not avoided, may result in property damage.

**CAUTION**

Caution indicates a potentially hazardous situation which, if not avoided, may result in minor or moderate injury.

**WARNING**

Warning indicates a potentially hazardous situation which, if not avoided, could result in death or serious injury.

**DANGER**

Danger indicates an imminently hazardous situation which, if not avoided, will result in death or serious injury.

1.3 NIOSH Approval

1.3.1 The Clem-Cool Air Conditioner is approved by NIOSH to use with Clemco Apollo respirators.

1.3.2 The NIOSH label shown below lists the Apollo respirator approval numbers. An X on the approval line indicates which components are approved for the specific respirator. Do not use any non-approved components with the respirator.

Clemco Industries Corp.  
Washington MO, USA  
(636) 239-0300

TYPE C AND CE CONTINUOUS FLOW SUPPLIED-AIR RESPIRATOR IS APPROVED ONLY IN THE FOLLOWING CONFIGURATIONS:

TC#	Protection <sup>1</sup>	Part No.	Model	Respirator Components										Cautions and Limitations <sup>2</sup>			
				Helmets		Alternate Regulators				Hose Air Lines							
				Apollo 60	Apollo 600	CAT	CCT	Clem-Cool A/C	CFC/High Pressure	CFC/Low Pressure	ACV	Yellow 3/8" x 25 Ft.	Yellow 3/8" x 50 Ft.		Yellow 3/8" x 100 Ft.	Black 1/2" x 100 Ft.	Black 1/2" x 50 Ft.
19C-338	CF/SA																BCDEJM NOS
19C-339	CF/SA																BCDEJM NOS
19C-130	CF/SA																BCDEJM NOS
19C-358	CF/SA																BCDEJM NOS

**1 PROTECTION**  
CF - Continuous Flow SA - Supplied-air

**2 CAUTIONS AND LIMITATIONS**

B- Not for use in atmospheres immediately dangerous to life or health.  
 C- Do not exceed maximum use concentrations established by regulatory standards.  
 D- Air-line respirators can be used only when the respirators are supplied with respirable air meeting the requirements of CGA G-7.1 Grade D or higher quality.  
 E- Use only the pressure ranges and hose lengths specified in the user's instructions.  
 J- Failure to properly use and maintain this product could result in injury or death.  
 M- All approved respirators shall be selected, fitted, used, and maintained in accordance with MSHA, OSHA, and other applicable regulations.  
 N- Never substitute, modify, add, or omit parts. Use only exact replacement parts in the configuration as specified by the manufacturer.  
 O- Refer to users instructions, and/or maintenance manuals for information on use and maintenance of these respirators.  
 S-Special or critical users instructions, and/or specific use limitations apply. Refer to instruction manual before donning.

## **⚠ WARNING**

**NIOSH approval applies to items shown on the label when used as a complete system. Do not make any non-approved modification, deletion, or substitution. Non-approved components void the NIOSH approval and may permit ingress of toxic and hazardous dust, resulting in toxic poisoning and respiratory disease.**

### 1.4 OSHA Regulations

**1.4.1** OSHA Regulation 29 CFR 1910.134 for respiratory protection in General Industry is referenced throughout this document. Respiratory protection standards for Construction 29 CFR 1926.103 and for Maritime 29 CFR-1915.154, 1917, and 1918 refer to 1910.134. The complete regulation is available through the U.S. Dept. of Labor web site at [www.osha.gov](http://www.osha.gov).

**1.4.2** OSHA Regulations 29 CFR 1910.134(a) and (c) require the employer to establish and maintain a comprehensive, written, respiratory protection program administered by a suitably-trained program administrator. The program must include, but is not limited to the following:

1. Procedures for selecting NIOSH-certified respirators.
2. Medical evaluations of employees required to use respirators.
3. Fit testing procedures.
4. Procedures for proper use of respirator in routine and foreseeable emergency situations.
5. Procedures and schedules for cleaning, disinfecting, storing, inspecting, repairing, discarding and otherwise maintaining respirators.
6. Procedures to ensure adequate air quality, quantity and flow of breathing air for atmosphere-supplying respirators.
7. Training of employees in the respiratory hazards to which they are potentially exposed during routine and emergency situations.
8. Training of employees in the proper use of the respirators, including putting on and removing them, any limitations on their use, and their maintenance.
9. Procedures for regularly evaluating the effectiveness of the program.

**1.4.3** It is essential that the user be properly instructed in the use and maintenance of the respirator. The respirator manual and this manual for the air conditioner must be made available to all users of the respirator, and the users must demonstrate their understanding of its subject matter. Read the entire manual before installing or operating the equipment.

**1.4.4** The air conditioner must be supplied with respirable air meeting requirements described herein. It is the responsibility of the employer to provide quality breathing-air to the respirator, and to establish a program to ensure that the respirator and accessories are properly used and maintained.

### 1.5 Description

**1.5.1** The Clem-Cool Air Conditioner is an approved alternate air control device, which provides the user with a source of cool air when used in conjunction with a Clemco supplied-air respirator or Comfort Vest. The illustration in Figure 1 shows components and controls for the Clem-Cool air conditioner.

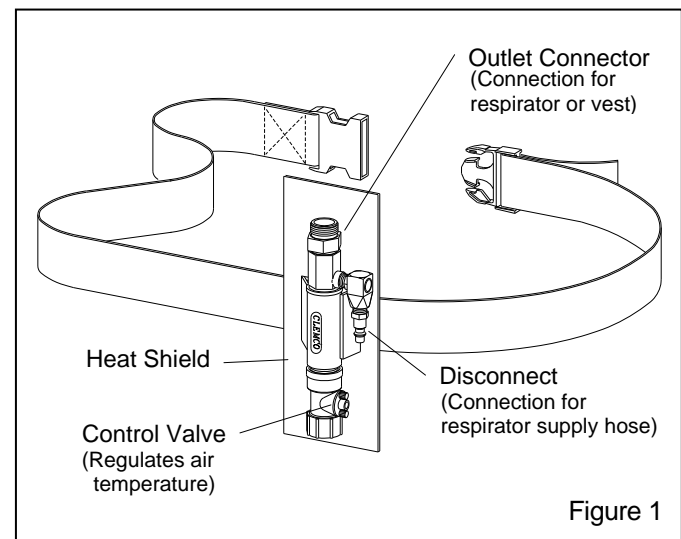

## 2.0 AIR SUPPLY

### 2.1 Air Quality

## **⚠ DANGER**

**Never connect a breathing air line to an air source that has not been tested for gas and particulate contamination. The presence of unacceptable levels of carbon monoxide (CO) or other gases, or oxygen deficiency in breathing air will cause death to the user.**

**2.1.1** The employer is responsible for ensuring that breathing air shall meet the requirements for Grade D or higher quality, as described in Compressed Gas Association Commodity Specification pamphlet G-7.1., titled Commodity Specification For Air, published by Compressed Gas Association Inc., Chantilly, VA. Website: [www.cganet.com](http://www.cganet.com), (29 CFR 1910.134 (i)).

2.1.2 Limiting characteristics of Grade D air, as of the publication of this manual is as follows:

- Carbon Dioxide ..... maximum of 1000 ppm
- Carbon Monoxide ..... maximum of 10 ppm
- Odor ..... \*No pronounced odor
- Oil (hydrocarbons) .....maximum of 5 mg/m<sup>3</sup>
- Oxygen .....between 19.5 - 23.5%

\* Specific measurement of odor in gaseous air is impractical. Air may have a slight odor but the presence of a pronounced odor renders the air unsatisfactory.

2.1.2 Special care must be taken to avoid accidental connection to any lines other than compressed air, such as, oxygen, acetylene, or nitrogen.

2.1.3 When the air conditioner is used for breathing air, the quality of air supplied to the air conditioner is extremely critical to the safety of the user.

2.1.4 Any air inhaled from the air conditioner must meet the requirement for respirable air as stated herein. If the air conditioner supplies air to a vest that is used with a hooded respirator, air supplied to the vest must also be respirable air meeting the requirements for Grade D or better.

2.1.6 Prior to using the respirator, read the owner's manual and all instructions, labels, and warnings relating to the compressed air source. Take special care to abide by all warnings from the compressor manufacturer regarding compressor use, and from the cylinder and air supplier, for breathing air cylinders and their use.

2.1.7 A Clemco CPF filter may be installed and regularly maintained to remove objectionable odors, oil mist, water, pipe scale, and other particulate matter.

2.2 Breathing-Air from Cylinders

DANGER

**Operators must never use or operate breathing air cylinders, without proper pressure reducing devices, and training on their use. Breathing cylinders are under extremely high air pressure. Improper use could cause cylinders or accessories to rupture, resulting in severe injury or death.**

2.2.1 Using cylinders (high-pressure air bottles) requires special knowledge of their use and compliance with OSHA Regulations. Refer to 29 CFR 1910.134(h) and (i) and 49 CFR part 173, and part 178.

2.2.2 The employer shall ensure that cylinders used to supply breathing air to respirators meet all requirements which may include, but are not limited to, their testing and maintenance, a certificate of analysis for air quality and moisture.

2.2.3 Cylinders must be equipped with a properly maintained pressure-reducing valve that reduces pressure to the approved pressure range as shown in Section 2.4.3.

2.3 Breathing-Air from Compressors

2.3.1 The employer shall ensure that air from compressors used to supply breathing air to respirators meets the requirements in 29 CFR 1910.134.(i)(5).

2.3.2 Precautions must be taken to prevent contaminants from entering the compressor intake: Ref. 29 CFR 1910.134.(i)(5)(i). The compressor inlet must be located away from all sources of toxic contaminants including carbon monoxide, which is found in engine exhaust (including the exhaust from the compressor's engine), and in any form of combustion. No vehicles should be allowed near the compressor intake. Contaminants can enter respiratory equipment through the compressor air inlet. This inlet must not be located near any exhaust system outlet, ventilation flue, or source of fumes or particles of any kind.

2.3.3 The compressed-air supply system must be equipped with suitable in-line air-purifying sorbent beds and filters, and be maintained to further ensure breathing air quality: 29 CFR 1910.134 (iii).

2.3.4 If the breathing-air supply is from a non-oil-lubricated compressor, the employer shall ensure that the carbon monoxide levels in the breathing air do not exceed 10 ppm: 29 CFR 1910.134 (i)(6).

2.3.5 If an oil-lubricated compressor is used, the employer shall use a high-temperature alarm or carbon monoxide (CO) alarm, or both, to monitor carbon monoxide levels. If only high-temperature alarms are used, the air supply shall be monitored at intervals sufficient to prevent carbon monoxide in the breathing air from exceeding 10 ppm: 29 CFR 1910.134 (i)(7).



**2.4 Operating Pressure**

**2.4.1** Air pressure at the point of attachment (the point of attachment is where the respirator supply hose is connected to the respirable air source) must be maintained at pressures between 90 to 100 psi (pounds per square inch), as shown in the table in Section 2.4.3. Maintaining the correct operating pressure at the point of attachment ensures the correct air flow to the respirator.

**2.4.2** The Clemco CPF Inline Particulate Filter with regulator meets this requirement for a regulator and gauge, provided inlet pressure does not exceed 150 psi.

**⚠ DANGER**

**Do not connect the air conditioner, CPF Filter, or any other regulator or filter, to bottled air that does not have a pressure reducing valve that reduces pressure to the maximum operating pressure of the respirator or filter it services. Failure to comply with this warning will cause devices rated at lower pressures to rupture under the high pressure of bottled air, which could cause severe injury or death.**

**2.4.3** Use the following table to determine the minimum pressure setting and maximum respirator hose length that may be used with the air conditioner. Adjust the pressure with the respirator hose and respirator attached. If the regulator is adjusted with static pressure (no air flow), pressure may drop below the required pressure when the respirator is connected, and may result in low air flow. Setting the pressure as shown provides a minimum of 7 cfm (cubic feet per minute) to the respirator. The maximum allowable pressure for use with the air conditioner is 100 psi.

Minimum Pressure	Overall hose length measured in feet							
	25	50	75	100	125	150	175	200
90 psi	x	x	x					
95 psi				x	x	x	x	x

The maximum overall hose length used with the air conditioner is 200 feet when providing air to a respirator.

**2.5 Air Volume**

**2.5.1** The air conditioner must be supplied with 20 cfm of Grade D breathing air at 90 to 100 psi.

**⚠ WARNING**

**The compressor must provide adequate output and the plumbing between the compressor and the point of attaching the respirator hose must have sufficient capacity to supply the volume of air at the pressure required. Restricted air flow will cause discomfort to the user, and may result in ingress of hazardous and toxic dust, subjecting the user to health and life threatening toxic poisoning and long term respiratory disease and death.**

**3.0 SET-UP and ADJUSTMENTS**

**3.1 Attach Breathing Tube Assembly**

**⚠ CAUTION**

**Note the directional flow arrows on the labels at both ends of the breathing tube. The flow arrows indicate the direction of air flow to the helmet. Flow arrows must point toward the helmet. Failure to properly attach the breathing tube may damage the tube's acoustical foam, which will block air flow, or it may increase noise levels beyond OSHA limits.**

**3.1.1** The breathing tube has a clamped-on end and a molded-on end. Attach the molded-on swivel connector to the air conditioner's outlet as shown in Figure 2.

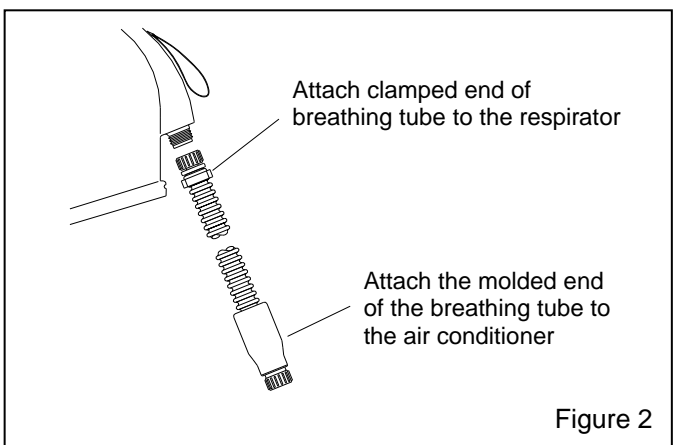

Figure 2

**3.1.2** Attach the clamped-on end to the threaded air inlet fitting at the back of the helmet as shown in Figure 2. Do not over-tighten; hand-tight is sufficient.

**3.1.3** Attach an approved Clemco respirator hose to the quick-disconnect nipple.

**3.2 Air Supply and Pressure**

**3.2.1** Initiate the air supply and regulate air pressure between 90 and 100 psi, as shown in Section 2.4.3.

**3.3** After donning the respirator, securely attach the belt and air conditioner around the waist. Adjust the belt size as required.

**3.4 Adjust Air Temperature**

**3.4.1** To adjust air temperature, rotate the temperature control valve (shown in Figure 3) located on the lower part of the air conditioner, toward "OFF" for ambient temperature or toward "ON" for maximum cooling. The valve may be positioned anywhere in between to attain the most comfortable temperature setting.

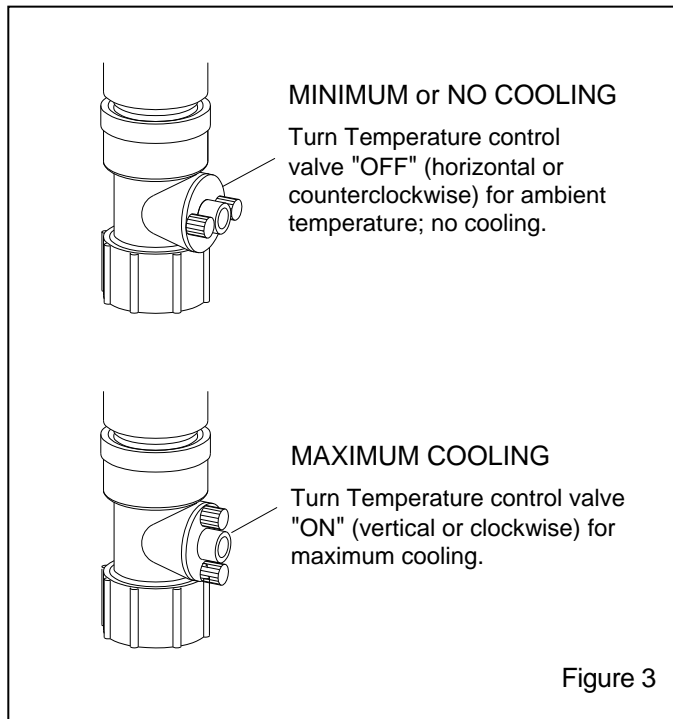

**4.0 PREVENTIVE MAINTENANCE**

**There are no serviceable parts within the conditioner.**

**4.1 Air Filter Screen**

**4.1.1** Inspect and clean the air filter screen monthly. If inadequate air flow is experienced, stop using the air conditioner and inspect the screen for blockage.

**CAUTION**

**Debris or abrasion on the screen is one indication of dirty air. Dirty air will cause rapid erosion of critical parts of the air conditioner, which will decrease efficiency and life of the conditioner.**

**4.1.2** To clean the air filter screen, unscrew the quick disconnect nipple from the inlet elbow. Turn the elbow upside down and tap it on a solid surface to remove loose debris. The screen can be removed by tapping the elbow described above. If the screen is wedged in place it may be necessary to destroy it in order to remove it. Replace the screen before reassembly.

**5.0 TROUBLESHOOTING**

**5.1 Inadequate Air Flow**

**5.1.1** Check filter screen for debris.

**5.1.2** Make sure supply air pressure is between 90 and 100 psi. A pressure regulator and gauge must be installed at the point of attachment (where the respirator supply hose is connected to the respirable air source).

**5.2 Poor Cooling Performance**

**5.2.1** Inadequate air flow affects cooling performance. Refer to Paragraph 5.1.

**5.2.2** The temperature of the compressed air has an effect on the air conditioner's discharge temperature. Make sure that none of the lines that supply compressed air to the conditioner is routed near any source of heat, such as a steam radiator, furnace, etc. When possible avoid exposure to direct sunlight.

**5.2.3** Erosion of internal parts: Compressed air moving through the air conditioner will eventually wear critical components. Dirty air accelerates wear of internal parts. There are no replaceable parts within the conditioner.

6.0 REPLACEMENT PARTS, FIGURE 3

Item	Description	Stock No.
(-)	Clem-Cool Air Conditioner Assembly with belt .....	23825

1.	Belt, 2" web .....	04430
2.	Disconnect, 1/4" NPT male .....	00015
3.	Elbow, 1/4" NPT swivel .....	23829
4.	Screen .....	08973
5.	Heat shield .....	08981

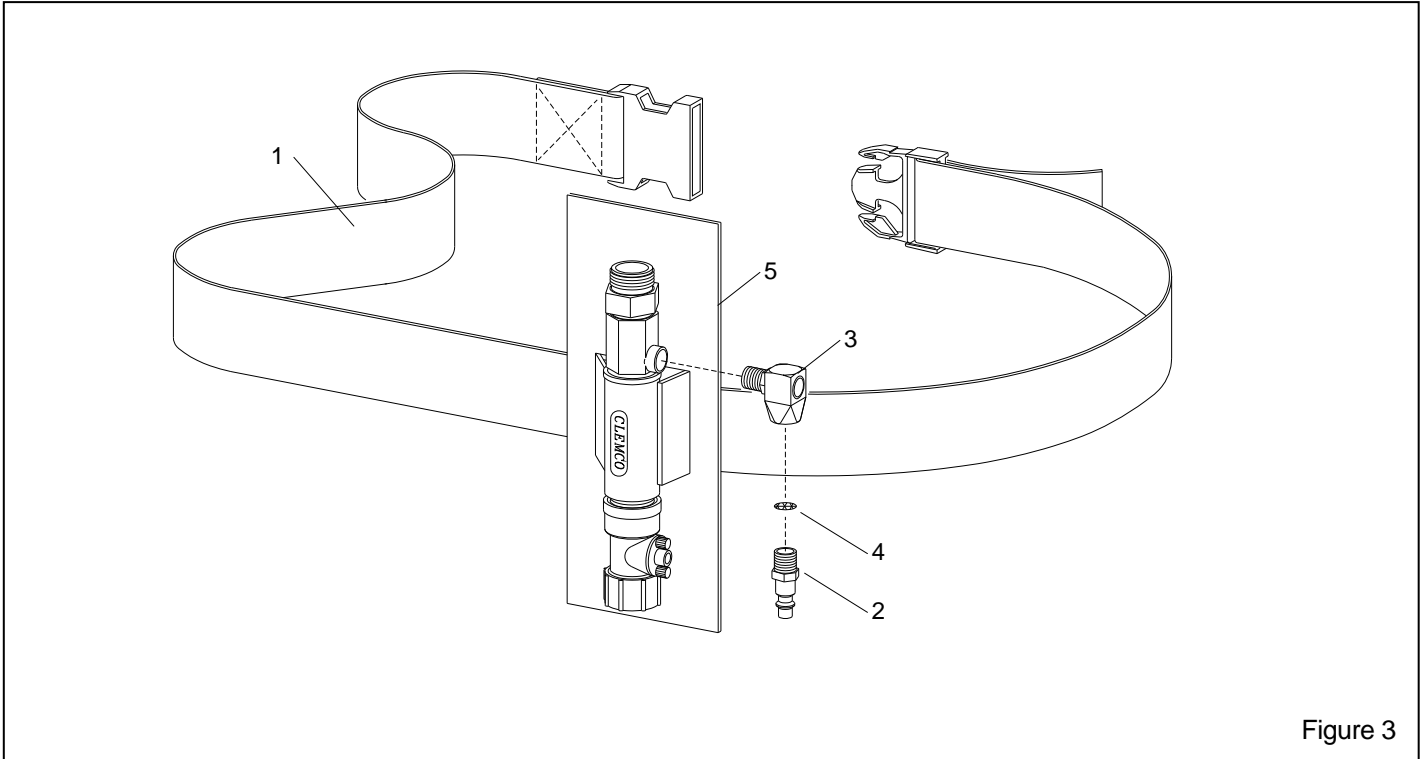

Figure 3